

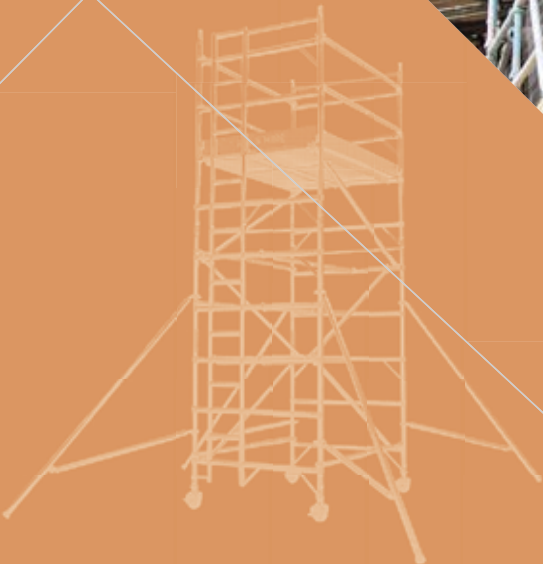

CODE OF PRACTICE FOR ACCESS AND WORKING SCAFFOLDS





**Our Vision:
Healthy, safe and
productive lives and
enterprises**

Contents

Foreword	1
1. Introduction	3
1.1 Background	3
1.2 Scope of Code of Practice	3
1.3 Scaffolding in Construction	4
1.4 Types of Scaffold	4
1.5 Scaffolding Hazards	5
1.6 Risk Assessment	6
1.7 Statutory Duties	8
1.7.1 The Client	10
1.7.2 Project Supervisor for the Design Process (PSDP)	10
1.7.3 Designers	10
1.7.4 Project Supervisor for the Construction Stage (PSCS)	10
1.7.5 Contractors	11
1.7.6 Workers	12
1.8 Illustrations	13
1.9 Definitions	13
1.9.1 General Scaffolds	13
1.9.2 System Scaffolds	14
1.9.3 Other Common Scaffolding Terms	14
1.9.4 Definitions in Safety, Health and Welfare at Work (General Application) Regulations 2007, Part 4: Work at Height	16
2. Management and Control of Scaffolding	17
2.1 Management of Scaffolding Activities	17
2.2 Choice of Scaffolding Equipment	23
2.3 Layout and Design	23
2.3.1 Layout	23
2.3.2 Structural Design of Scaffolds	23
2.3.3 Building Design and Scaffold Erection	25
2.3.4 Co-ordination of Temporary Work	25
2.4 Erection Scheduling	26
2.5 Planning for Use and Maintenance	26
2.6 Information to Purchasers or Hirers of Scaffolding Equipment	26
2.7 Information to Users of Scaffolding Equipment	27
3. Erection of Scaffolds	28
3.1 Safe Erection and Dismantling	28
3.1.1 Safety of Scaffolders	30
3.1.2 Safety of Other Workers and People	30
3.1.3 Incomplete Scaffolding	30

CODE OF PRACTICE

FOR ACCESS AND WORKING SCAFFOLDS

Contents

3.2	Materials.....	30
3.2.1	Scaffolding Provider’s Inspection Prior to Use.....	30
3.2.2	Standards.....	30
3.2.3	Transoms.....	31
3.2.4	Ledgers.....	31
3.2.5	Couplers.....	31
3.3	Stability.....	31
3.3.1	Foundations.....	32
3.3.2	Ties.....	33
3.3.3	Tie Spacing.....	38
3.3.4	Bracing.....	39
3.4	Working Platforms.....	43
3.4.1	Decking.....	44
3.4.2	Toe-Boards.....	44
3.4.3	Maximum Gap between Building and Platform.....	45
3.4.4	Cantilever Platform (Stage) Brackets.....	45
3.5	Guard-Rails.....	45
3.6	Falling Object Protection.....	45
3.6.1	Brick Guards.....	45
3.6.2	Sheeting.....	45
3.6.3	Fans.....	46
3.7	Access to the Scaffold.....	47
3.7.1	Ladder Access.....	47
3.8	Loading of the Scaffold.....	49
3.8.1	Loading Bays.....	49
3.8.2	Signs.....	51
3.8.3	Loading Charts.....	51
3.9	Free-Standing and Mobile Access Towers.....	51
3.9.1	Types of Tower.....	51
3.9.2	Manufacturer’s Instructions.....	53
3.9.3	Falls from a Height – During Assembly and Dismantling.....	53
3.9.4	Falls from a Height – Personal Fall Protection Equipment.....	54
3.9.5	Stability.....	54
3.9.6	Ground Surface.....	54
3.9.7	Bracing.....	55
3.9.8	Castors.....	55
3.9.9	Working Platform.....	55
3.9.10	Tower Access.....	55
3.9.11	Overhead Electricity Lines.....	55
3.9.12	Instruction, Training and Supervision.....	55
3.9.13	Tower Use.....	55

Contents

3.10 Electrical Dangers	57
3.10.1 Overhead Electricity Lines	57
3.10.2 Portable Electrical Equipment.....	58
3.10.3 Lightning.....	58
3.11 Erection on Public Streets/Places.....	58
3.11.1 Through Access.....	58
3.11.2 Adjacent Parking or Traffic.....	59
4. Inspection and Handover.....	60
5. Use, Modification and Maintenance	62
5.1 Scaffold Users	62
5.2 Modification.....	62
5.3 Maintenance.....	63
5.4 Inspection Before and During Use.....	63
6. Dismantling	64
6.1 Stability.....	64
6.2 Protection from Falls.....	64
6.3. Protection from Falling Objects.....	64
7. Competence	65
7.1 Competence of Scaffolders	65
7.1.1 Training.....	67
7.1.2 Experience	67
7.1.3 Assessment, Certification and Registration.....	67
7.1.4 Training from Other Jurisdictions	67
7.2 Competence for Inspection	67
7.3 Training and Instruction for Scaffold Users	68
7.4 Training and Instruction of Equipment Operators.....	68
Appendix A: Tube and Fitting Scaffolds	69
Tube and Fitting Scaffolds	70
Appendix B: Example Checklists	75
Checklist 1: Inspection of Scaffolding Materials Before Use.....	77
Checklist 2: Inspection of Scaffolding in Use	78
Certificate: Handover of Scaffolding to User.....	79
Appendix C: Form GA3 Report of Results of Inspections of Work Equipment for Work at a Height....	82
Appendix D: Weights of Typical Building Materials	86
Appendix E: Additional Information - Summary of Changes from Previous COP	
Additional References/Information Sources	91

Foreword

The Health and Safety Authority (by virtue of section 60 of the Safety, Health and Welfare at Work Act 2005), following consultation with the statutory Advisory Committee on Construction Safety (referred to as the “Construction Safety Partnership Advisory Committee”), the Construction Industry Federation and the National Association of Scaffolding and Access Contractors, the Irish Congress of Trade Unions and the general public (through the Authority’s website), and with the consent of Pat Breen TD, Minister of State for Trade, Employment, Business, EU Digital Single Market and Data Protection, publishes this updated Code of Practice entitled “Code of Practice for Access and Working Scaffolds”.

The aim of this Code of Practice is to provide practical guidance to scaffold erectors, contractors and users of scaffolding on the requirements and prohibitions set out in the relevant statutory provisions.

In particular, but not exclusively, this Code of Practice provides practical guidance on observance of the provisions of:

- (i) Chapter 1 of Part 2 (sections 8 to 12 in relation to the general duties of employers) and Chapter 2 of Part 2 (sections 13 to 14 in relation to the general duties of employees etc.) of the Safety, Health and Welfare at Work Act 2005 (No. 10 of 2005);
- (ii) Part 2 (Regulations 6 to 23 in relation to design and management); Part 3 (Regulations 24 to 29 in relation to the general duties of contractors and others) and Part 4 (Regulation 30 in relation to site safety and access to construction sites; Regulation 35 in relation to protection from falling material and protective safety helmets; Regulation 40 in relation to lighting of work places; Regulation 42 in relation to projecting nails and loose material; Regulation 43 in relation to construction of temporary structures and Regulation 44 in relation to avoidance of danger from collapse of structures) of the Safety, Health and Welfare at Work (Construction) Regulations 2013 (S.I. No. 291 of 2013); and

- (iii) Chapter 2 of Part 2 (Regulations 27 to 59 in relation to the use of work equipment), Chapter 3 of Part 2 (Regulations 62 to 67 in relation to personal protective equipment), Part 3 (Regulations 74 to 93 in relation to electricity) and Part 4 (Regulations 94 to 119 in relation to work at height) of the Safety, Health and Welfare at Work (General Application) Regulations 2007 (S.I. No. 299 of 2007) as amended by the Safety, Health and Welfare at Work (General Application) (Amendment) Regulations 2007 (S.I. No. 732 of 2007).

This Code of Practice comes into effect on January 1st 2019. Notice of publication was published in the Iris Oifigiúil of December 25th 2018. It replaces the Code of Practice for Access and Working Scaffolds issued by the Authority in 2009 in accordance with the Safety, Health and Welfare at Work Act 2005.



Foreword

As regards the use of Codes of Practice in criminal proceedings, section 61 of the 2005 Act provides as follows:

61. (1) Where in proceedings for an offence under this Act relating to an alleged contravention of any requirement or prohibition imposed by or under a relevant statutory provision being a provision for which a code of practice had been published or approved by the Authority under section 60 at the time of the alleged contravention, subsection (2) shall have effect with respect to that code of practice in relation to those proceedings.
- (2) (a) Where a code of practice referred to in subsection (1) appears to the court to give practical guidance as to the observance of the requirement or prohibition alleged to have been contravened, the code of practice shall be admissible in evidence.
- (b) Where it is proved that any act or omission of the defendant alleged to constitute the contravention—
- (i) is a failure to observe a code of practice referred to in subsection (1), or
 - (ii) is a compliance with that code of practice, then such failure or compliance is admissible in evidence.
- (3) A document bearing the seal of the Authority and purporting to be a code of practice or part of a code of practice published or approved of by the Authority under this section shall be admissible as evidence in any proceedings under this Act.

Dr. Marie Dalton
Secretary to the Board
Health and Safety Authority

I. Introduction

1.1 Background

The Code of Practice for Access and Working Scaffolds was first published in 1999, with a further update in 2008. The Code was the result of a joint initiative by the Health and Safety Authority, the Construction Industry Federation and the Irish Congress of Trade Unions to improve the standard of scaffolding. It was drafted in consultation with the organisations represented on the Construction Safety Partnership Advisory Committee.

This revised edition of the Code of Practice takes into account technical progress and recent changes to health and safety legislation.

1.2 Scope of Code of Practice

This Code of Practice applies to all places of work where scaffolds are used to provide working platforms, protection from falls or means of access during construction work.

The Code gives recommendations and guidance on the erection, use, inspection and dismantling of simple access and working scaffolds. It also gives recommendations and practical guidance on the training and instruction of those erecting, dismantling and using scaffolds.

The Code deals mainly with system scaffolds, as these are the most common scaffolds used in Ireland. It also contains outline guidance on the erection of basic tube and fitting scaffolds. The Code is not a technical guidance document and does not give detailed recommendations or guidance on special scaffolds such as cantilever, truss-out or slung scaffolds. Information in this Code needs to be read in conjunction with the manufacturer's manual and instructions and any scaffold design provided.

Reference is made in the Code to the UK NASC TG: 20 Good Practice Guidance for Tube and Fitting Scaffolding and NASC SG guidelines which provide references for various aspects of scaffold design and for safety during erection and use etc.

I.S. EN 12811 Part 1, 2004 specifies performance requirements and methods of structural and general design for access and working scaffolds, in particular where the scaffold relies on the adjacent structure for stability. In general, these requirements also apply to other types of working scaffold. This European standard also specifies structural design rules when certain materials are used and general rules for prefabricated equipment.

NOTE



This Code of Practice for access and working scaffolds is not a design manual.

While guidance is provided on the new requirements of I.S. EN 12810 and I.S. EN 12811; the reader is directed to I.S. EN 12811 Part 1 and associated guidance documents.

This code outlines the health and safety issues relating to the design, erection, use and dismantling of acaffolds

HSA Code of Practice

These European standards set out performance requirements and rules for the design of access and working scaffolds

I.S. EN 12810 & 12811

Guidance documents are available, which explain the requirements of EN 12811 Part 1

Refer to Appendix E

I. Introduction

Information on scaffolding materials and testing requirements is provided in I.S. EN 12811 Part 2, 2004: *Temporary works equipment – Part 2: Information on materials and I.S. EN 12811 Part 3, 2002: Temporary works equipment – Part 3: Load testing.*

The requirements for façade scaffolds are dealt with in I.S. EN 12810 Part 1, 2004: *Façade scaffolds made of prefabricated components – Part 1: Products specifications and I.S. EN 12810 Part 2, 2004: Façade scaffolds made of prefabricated components – Part 2: Particular methods of structural design.*

1.3 Scaffolding in Construction

Scaffolding performs several important functions during the construction process. It provides a temporary working platform to enable work to be performed at a height. It is also used to protect people working at a height from falling and to protect people working below from the dangers of falling objects.

Falling from a height is one of the most common causes of accidental death and serious injury in the construction industry. Scaffolding that is adequately erected and maintained can prevent such accidents.

1.4 Types of Scaffold

There are currently two main types of scaffolding in use in Ireland: system scaffolds and tube and fitting scaffolds.

System scaffolding has become the most common type of scaffolding in use due to its ease of erection, ease of use and reduced labour requirements. A system scaffold is a scaffold made of prefabricated elements and designed and manufactured in accordance with I.S. EN 12810 Part 1, 2004 or an equivalent standard. Each type of system scaffolding consists of a range of components such as standards, ledgers, transoms and base plates and has its own specific erection requirements. Each system scaffold must be supplied with an appropriate manufacturer's instruction manual as to how the system is to be erected.

The manual will generally give the user a few generic designs for a variety of basic configurations of the system. If the user varies from the manual when erecting the scaffold, then a specific bespoke scaffold design will be required. There may be different manufacturers of the same type of system scaffolding. If more than one manufacturer's system is being used, then these must be compatible with each other and have clear evidence of conformity from the system manufacturers or suppliers including instructions on how to erect the scaffolds.

Examples of some of the different system scaffolds used are illustrated below.

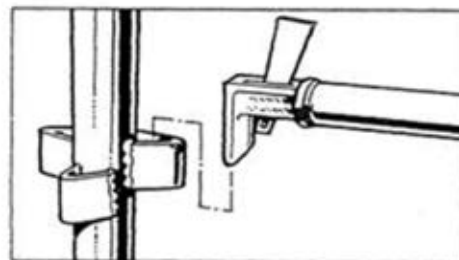

Wedge type system scaffolding

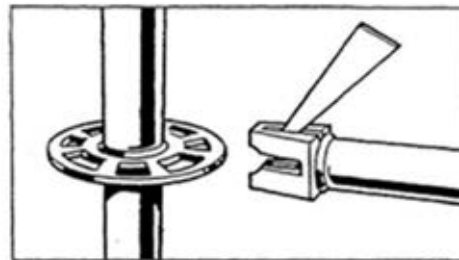

Ring type connection system scaffold

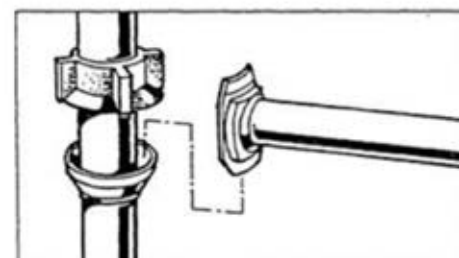

Cup type connection system scaffold

Figure 1: Connection Nodes of Some Different System Scaffolds

I. Introduction



PROPRIETARY SCAFFOLDS / SYSTEM SCAFFOLDS

All system scaffolds (using prefabricated components) must follow the requirements of I.S.EN 12810 Façade scaffolds made of prefabricated components and associated standards.

- I.S. EN 12810 Part 1, 2004: Product specifications
- I.S. EN 12810 Part 2, 2004: Particular methods of structural design

Tube and fitting scaffolding is constructed from steel tubing and several types of couplers. Properly constructed, it forms a robust structure since the ledgers and standards are usually continuous across several bays or lifts.



TUBE AND FITTING SCAFFOLDS

All tube and fitting scaffolds must follow the requirements of I.S. EN 12811 Temporary works equipment - scaffolds and associated standards.

- I.S. EN 12811 Part 1, 2004: Performance requirements and general design
- I.S. EN 12811 Part 2, 2004: Information on materials
- I.S. EN 12811 Part 3, 2002: Load testing

1.5 Scaffolding Hazards



WARNING

Poorly erected or maintained scaffolds can fail, sometimes catastrophically!

Where a scaffold has inadequate foundations, tying or bracing, or if it is overloaded, it can collapse, endangering workers and the public. Where scaffold boards or guard-rails are missing, workers can suffer severe injuries due to falls. Scaffolders will be at risk where a safe system of work is not in place to protect them from falls.

I. Introduction

1.6 Risk Assessment



Figure 2: Risk Assessment Process

Project supervisors, designers and contractors have legal obligations in relation to risk assessment and each should seek to avoid risks.

Where the risks cannot be avoided, a risk assessment should be performed. The risk assessment should be based on the hazards in relation to the specific scaffold, e.g. adjacent overhead power lines, poor ground conditions or vulnerability to vehicle impact. It should assess how serious the risks are.

The risk assessment should take account of the nature of the work to be carried out, the loads and the height from which falls may occur.

The person undertaking the risk assessment needs to consider two aspects of the scaffolding work:

- the likelihood that someone could be injured during the delivery (unloading), erection, use or dismantling or removal (loading) of the scaffold; and
- how severe the potential injury could be.

The greater the likelihood and/or severity assessed will result in an increased risk that someone could be injured.

Appropriate precautions should then be taken to control the risk and to prevent injury. These precautions should be detailed in the safety statement and/or the safety and health plan, where appropriate.

Throughout the risk assessment process full account should be taken of the General Principles of Prevention, which are contained in Schedule 3 of the Safety, Health and Welfare at Work Act 2005 and reproduced in Table 1. These general principles set out a hierarchy of control measures that apply to all places of work.

The risk assessment for most scaffolding erection, use and dismantling will show that the level of risk is high unless there is a good standard of planning, design, equipment, training, supervision and checking to ensure safety.

I. Introduction

Table 1: General Principles of Prevention

General Principles of Prevention	How they can be Applied to Scaffolding
1. The avoidance of risk	Select a scaffolding system that will remove hazards that would otherwise exist during erection, use, maintenance and dismantling of scaffolds.
2. The evaluation of unavoidable risk	Erection and dismantling of scaffolds is a high risk activity and while it is difficult to completely avoid risks, unavoidable risks must be assessed so that control measures may be implemented to reduce these risks to an acceptable level.
3. The combating of risk at source	This principle indicates that it is better to design out, or minimise, risks where practicable rather than leave them to be dealt with on site.
4. The adaptation of work to the individual, especially regarding the design of places of work, the choice of work equipment and the choice of systems of work, with a view in particular to alleviating monotonous work and work at a predetermined work rate and to reducing their effect on health	This principle refers to the design of places of work and ergonomic considerations of the individual, for example the scaffolding design should take into consideration the site operatives who will be working at height, when the scaffolding is in use.
5. The adaptation of the place of work to technical progress	This principle refers to the duty to maintain pace with technical progress, as scaffolding systems develop and safety is improved.
6. The replacement of dangerous articles, substances, or systems of work by safer articles, substances or systems of work	The scaffolding designer and erector should consider the choice of materials and/or scaffolding systems available in achieving a scheme that reduces the risks as far as practicable (see 2 above).
7. The development of an adequate prevention policy in relation to safety, health and welfare at work, which takes account of technology, organisation of work, working conditions, social factors, and the influence of factors related to the working environment	The management of health and safety throughout the construction project through the Preliminary Safety and Health Plan (PSDP) and the Safety and Health Plan (PSCS). As a contractor, the scaffolding erector must provide information to the PSCS for inclusion in the Safety and Health Plan and communicate their control measures to other contractors that may be affected by the erection, use or dismantling of the scaffold.
8. Priority to be given to collective protection measures over individual protection measures	Reducing the risk to everyone exposed should be given preference to measures that only protect individuals. E.g. scaffolders working with leading guard rails so that they have edge protection at all times rather than relying on fall arrest devices.
9. The giving of appropriate training and instruction to employees	All employers are required to give appropriate training and instructions to their employees – including scaffolding erectors, so that they may discharge their duties under the Construction Regulations 2013 and other relevant statutory provisions.

I. Introduction

1.7 Statutory Duties

Different people have specific duties in relation to the supply, design, construction and use of scaffolds. These duties are set out in the relevant statutory provisions, including in particular but not exclusively:

SAFETY, HEALTH AND WELFARE AT WORK ACT 2005

Section 8 General duties of employer

Section 9 Information for employees

Section 10 Instruction, training and supervision of employees

Section 11 Emergencies and serious and imminent dangers

Section 12 General duties of employers to people other than their employees

Section 16 General duties of designers, manufacturers, importers and suppliers of articles and substances

Section 17 Duties related to construction work

SAFETY, HEALTH AND WELFARE AT WORK (CONSTRUCTION) REGULATIONS 2013

Part 2 Design and management

Part 3 General duties of contractors and others

Part 4 General safety provisions

Schedule 5 Construction Skills Certification Scheme

SAFETY, HEALTH AND WELFARE AT WORK (GENERAL APPLICATION) REGULATIONS 2007-2016

Part 2 Workplace and work equipment

Part 4 Work at height

The main duty holders for any project involving scaffold structures include suppliers; project supervisor for the design process (PSDP); designers of permanent works; designers of temporary works; designers of scaffold structures; project supervisor for the construction stage (PSCS), contractors and workers.

The interaction between these duty holders is represented in Figure 3.

I. Introduction

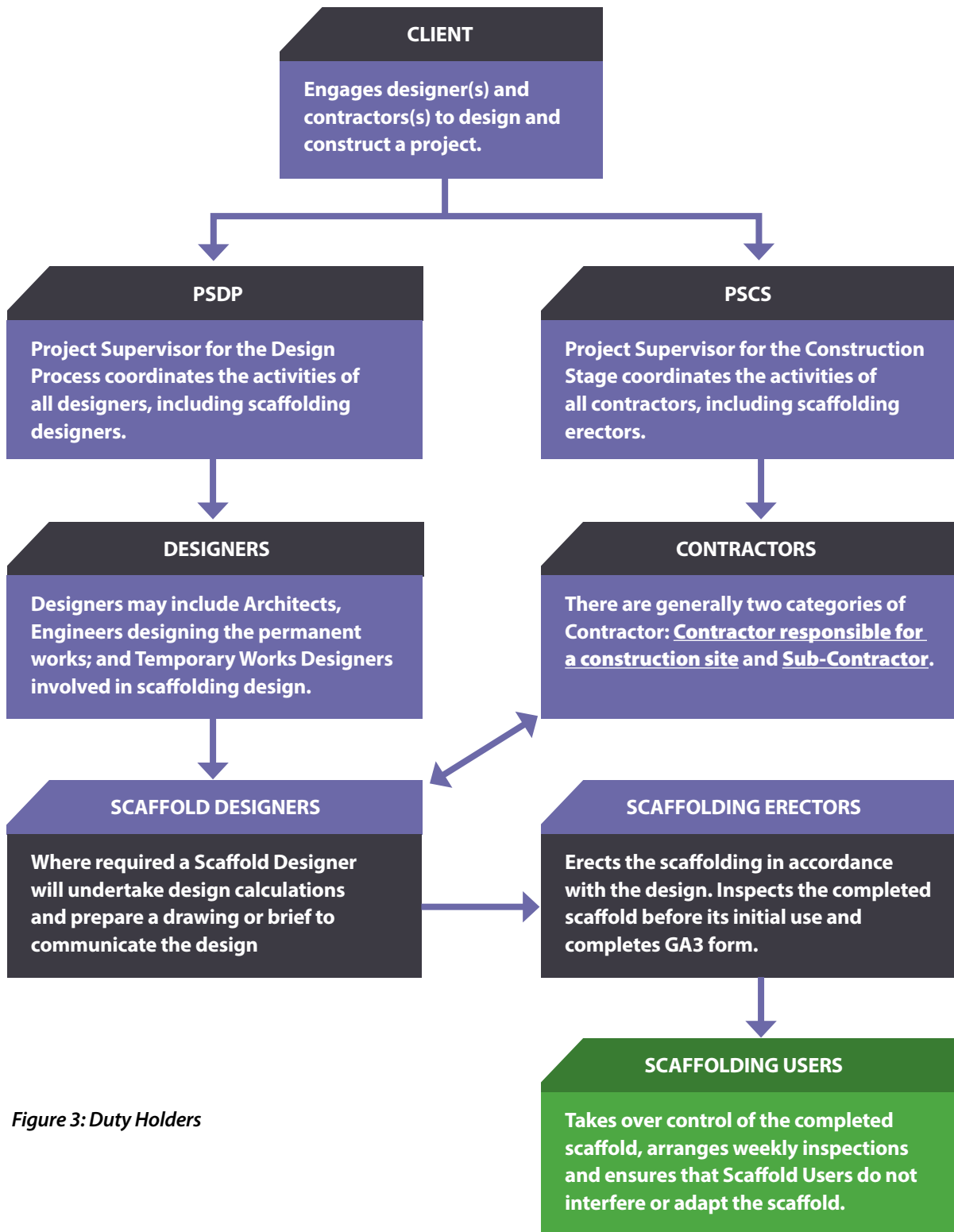

Figure 3: Duty Holders

I. Introduction

1.7.1 The Client

The Clients duties include to:

- take reasonable measures to ensure that persons they appoint as a designer, contractor or project supervisor is competent to carry out the work and have allocated, or will allocate, adequate resources to complete the work in a safe manner;
- make known to the designer, contractor, project supervisors any information that they have that is necessary for completing the design/construction of the project in a safe manner.

1.7.2 Project Supervisor for the Design Process (PSDP)

The duties of the PSDP include:

- identifying hazards arising from the design or from the technical, organisational, planning or time-related aspects of the project;
- communicating necessary control measures, design assumptions or remaining risks to the PSCS so they can be dealt with in the Safety and Health Plan;
- ensuring that the work of designers is co-ordinated to ensure safety;
- organising co-operation between designers;
- preparing a written safety and health plan for any project where construction will take more than 500 person days or 30 working days or where there is a particular risk and delivering it to the client prior to tender;
- preparing a safety file for the completed structure and giving it to the client;
- where appropriate, issuing directions to designers, contractors or others; and
- notifying the Authority and client of non-compliance with any written directions issued.

1.7.3 Designers

Designers of permanent structures and temporary scaffolds have duties which include:

- identifying any hazards that their design may present during construction and subsequent maintenance;
- where possible, eliminating the hazards or reducing the risk;
- communicating necessary control measures, design assumptions or remaining risks to the PSDP so they can be dealt with in the Safety and Health Plan;
- co-operating with other designers and the PSDP or PSCS;
- taking account of any existing safety and health plan or safety file;
- complying with directions issued by the PSDP or PSCS;
- where no PSDP has been appointed, informing the client that a PSDP must be appointed; and
- ensuring that the project is capable of being constructed to be safe, can be maintained safely, and complies with all relevant health and safety legislation, as required by the Safety, Health and Welfare at Work Act 2005.

1.7.4 Project Supervisor for the Construction Stage (PSCS)

The PSCS has significant duties in relation to the safety of scaffolding. These duties include:

- co-ordinating the implementation of the construction regulations by contractors;
- organising co-operation between contractors and providing information;
- developing the preliminary safety and health plan from the PSDP into the construction stage safety and health plan;

I. Introduction

- co-ordinating the reporting of accidents to the Authority;
- notifying the Authority before construction commences where construction is likely to take more than 500 person days or 30 working days;
- providing information to the site safety representative;
- co-ordinating the checking of safe working procedures;
- co-ordinating measures to restrict entry to the site;
- co-ordinating the provision and maintenance of welfare facilities;
- co-ordinating arrangements to ensure that craft, general construction and security workers have a Safety Awareness card, e.g. Safe Pass, and a Construction Skills card where required;
- co-ordinating the appointment of a site safety representative where there are more than 20 people on site;
- appointing a safety adviser where there are more than 100 people on site;
- providing all necessary safety file information to the PSDP;
- monitoring the compliance of contractors and others, and taking corrective action where necessary;
- where appropriate, issuing directions to designers or contractors;
- notifying the Authority and the client of non-compliance with any written directions issued; and
- ensuring that arrangements are in place to communicate the requirements of the scaffold users to the scaffold erectors.

1.7.5 Contractors

Contractors, including sub-contractors and specialist scaffolding contractors, have a very significant range of responsibilities under the relevant statutory provisions. These duties include:

- co-operating with the PSCS;
- providing a copy of their safety statement and relevant information to the PSCS;
- providing the PSCS with information required for the safety file, for forwarding to the PSDP;
- complying with the directions of project supervisors;
- reporting accidents to the Authority and to the PSCS where an employee cannot perform his or her normal work for more than three days;
- complying with site rules and the safety and health plan and ensuring that their employees comply;
- identifying hazards and either eliminating them, where possible, or reducing risks during construction;
- facilitating the site safety representative;
- ensuring that relevant workers have a safety awareness card and a construction skills card where required;
- providing workers with site-specific induction;
- appointing a safety officer where there are more than 20 people on a site or more than 30 employed in total directly by the contractor;
- consulting workers and safety representatives; and
- monitoring compliance and taking corrective action.

I. Introduction

NOTE

Every contractor using a scaffold should be satisfied, before using the scaffold, that it is stable, that it is safe to use, that the materials are of sound construction and that the safeguards required by the regulations are in place.

A contractor may not use a scaffold unless it has been inspected before use and within the previous seven days and the results of the inspections have been recorded. You can use either your own form for recording the inspections or the sample form GA3 scaffold template provided by the Health and Safety Authority in Appendix C.

Where a scaffolding contractor is engaged by another contractor to construct, maintain or dismantle a scaffold, then each contractor will assume several duties under the regulations. The agreement between contractors must clearly state which contractor is responsible for fulfilling which specific duties. For example, while the contractor responsible for the site must ensure that the scaffolding is inspected, the agreement should be clear as to which contractor is going to carry out the inspections of the scaffold. Refer to the Scaffolding Handover Form in Appendix B and form GA3 in Appendix C.

Due to the various contract types for erecting scaffolding it is essential that there is clarity around

who is responsible for the scaffolding and in particular for any modifications or adjustments required and for scaffold maintenance and inspection.

Any contractor using their own scaffolding and their own scaffolders or hiring in scaffolders to erect their scaffolding, must ensure that the scaffolding they provide is in safe working order and that all components required to erect the scaffolding safely are provided. Ultimately the day-to-day management of the scaffolding is the responsibility of the contractor responsible for the site.

All contractors using a scaffold must be satisfied that an inspection has been undertaken, as required. This can be achieved by looking at the report of inspections.

1.7.6 Workers

Under the relevant statutory provisions, workers, including scaffold erectors, have responsibilities such as:

- taking care of their own safety and the safety of others;
- co-operating with their employer and taking account of training and instruction given by the employer;
- making full use of harnesses, helmets and other protective equipment provided;
- reporting to their employer any defects in the scaffold or in the system of work that may endanger health and safety; and
- not interfering with or misusing the scaffold.



WARNING

Unauthorised removal of ties or scaffolding components can alter the stability of the scaffolding, resulting in sudden and catastrophic collapse.

Scaffold users must not interfere with the scaffolding. If you are using the scaffold:

- **DO NOT ALTER THE SCAFFOLD!**
- **DO NOT REMOVE TIES!**

I. Introduction

Scaffold erectors should ensure that, at the time of handing over the scaffold to the contractor, the scaffold is fit for its intended purpose and is in a safe and stable condition.

Any subsequent alteration that may be required during the use of the scaffolding must only be undertaken by a trained and competent scaffolder.

1.8 Illustrations

The illustrations used in this Code of Practice show a type of system scaffold that is commonly used in Ireland. The illustrations are intended to apply to simple access and working scaffolds in general. They do not supersede or replace the illustrations or arrangements contained in the system manufacturer's erection instructions.

The illustrations are schematic and, in some cases, may not show all the scaffolding components. For example, toe-boards have been omitted in some figures for clarity. They are for illustrative purposes only and scaffold designers and erectors must always refer to the appropriate European standard and the manufacturer's instructions.

1.9 Definitions

For the purposes of this Code of Practice, the following definitions apply (see also Figure 3).

1.9.1 General Scaffolds

Anchorage means inserted in, or attached to, the structure for attaching a tie member. Note: the effect of an anchorage may be achieved by the tie being connected to a part of the structure primarily intended for other purposes.

Base jack is a base plate that has a means of vertical adjustment.

Base plate is a plate used for spreading the load in a standard over a greater area.

Birdcage scaffold is a scaffold structure comprising a grid of standards and a decked area usually intended for working or storage.

Bracing in horizontal plane/plan bracing is an assembly of components that provides shear stiffness in the horizontal planes, e.g. by decking components, frames, framed panels, diagonal braces and rigid connections between transoms and ledgers or other items used for horizontal bracing.

Bracing in vertical plane is an assembly of components that provides shear stiffness in the vertical planes, e.g. by closed frames with or without corner bracing, open frames, ladder frames with access openings, rigid or semi-rigid connections between horizontals and the vertical components, diagonal bracing, or other items used for vertical bracing.

Cladding is a material normally intended to provide weather and dust protection, typically sheeting or netting.

Coupler is a device used to connect two tubes.

Debris Netting is a pervious cladding material.

Design means the preparation on any drawings, particulars, specifications, calculations and bills of quantities insofar as they contain specifications or other expressions of purpose, according to which a project, or any part or component of a project, is to be executed. This includes temporary works designs such as scaffolding.

Ledger is a horizontal member normally in the direction of the larger dimension of the working scaffold.

Modular system is a system in which transoms and standards are separate components where the standards provide facilities at predetermined (modular) intervals for the connection of other scaffold components.

Node is a theoretical point where two or more members are connected, usually at the intersection between a standard and a ledger.

I. Introduction

Parallel coupler is a coupler used for connecting two parallel tubes.

Platform is one or more platform units in one level within a bay.

Platform unit is a unit (prefabricated or otherwise) that supports a load on its own and that forms the platform, or part of the platform, and may form a structural part of the working scaffold.

Right angle double coupler is a load-bearing coupler for joining two tubes together at right angles.

Sheeting is an impervious cladding material.

Side protection is a set of components forming a barrier to protect people from the risk of falling and to retain materials.

Single coupler is a non-load bearing coupler typically used for joining transoms to ledgers on tube and fitting scaffolding.

Sleeve coupler is a coupler used for joining two tubes located co-axially.

Standard is an upright member.

Swivel coupler is a coupler used for connecting two tubes crossing at any angle.

Tie member is a component of the scaffold that connects it with an anchorage at the structure.

Transom is a horizontal member normally in the direction of the smaller dimensions of the working scaffold.

Uniformly Distributed Load (UDL) is a load distributed evenly along the length of a member or working platform.

Working area is the sum of the platforms in one level, which provides an elevated safe place for people to work on and to have access to their work.

Working scaffold is the temporary construction that is required to provide a safe place of work and the necessary access for the erection, maintenance, repair or demolition of buildings and other structures.

1.9.2 System Scaffolds

Scaffold system is:

- a) a set of interconnecting components, mostly purpose-designed for the scaffold system;
- b) the assessed standard set of system configurations; and
- c) the product manual.

Component is a part of a scaffold system that cannot be dismantled further, e.g. diagonal or vertical frame.

Configuration is a particular arrangement of connected components.

Connection device is a device that connects two or more components.

Element is an integral (e.g. welded) part of a component, such as a transom of a vertical frame.

System configuration is a configuration of the scaffold system comprising a complete scaffold or a representative section from it.

A **standard set of system configurations** is a specified range of system configurations for structural design and assessment.

System width (SW) is the maximum width class of Table 1 of I.S. EN 12811-1, 2004 that can be realised between the standards.

1.9.3 Other Common Scaffolding Terms

Brick guard is a metal or other fender filling the gap between the guard-rail and the toe-board, and sometimes incorporating one or both components.

Bridle is a tube fixed across an opening or parallel to the face of a building to support the inner end of a transom or tie tube.

I. Introduction

Butting transom is a transom extended inwards to butt the building to prevent the scaffolding moving towards the building.

Butting tube is a tube that butts up against the façade of a building or other surface to prevent the scaffold moving towards that surface.

Cantilever bracket or stage bracket is a bracket usually attached to the inside of a scaffold to enable boards to be placed between the scaffold and the building.

Castor is a swivelling wheel secured to the base of a vertical member to mobilise the scaffold.

Check coupler is a coupler added to a joint under load to give security to the coupler(s) carrying the load.

Decking Units are proprietary components that can be used to provide access and working platforms.

End guard-rail is a guard-rail placed across the end of a scaffold or used to isolate an unboarded part of the scaffold.

End toe-board is a toe-board at the end of a scaffold or at the end of a boarded portion of it.

Façade brace is a brace parallel to the face of a building.

Guard-rail is a member incorporated in a scaffold to prevent the fall of a person from a platform or access way.

Joint pin is an expanding fitting placed in the bore of a tube to connect one tube to another coaxially (see also *Spigot*).

Kentledge is a dead weight, built in or added to a structure to ensure adequate stability.

Knee brace is a brace across the corner of an opening in a scaffold to stiffen the angles or to stiffen the end support of a beam.

Ledger brace is a brace at right angles to the building in a vertical plane.

Movable tie is a tie that may be temporarily moved for the execution of work.

Non-movable tie is a tie that will not be moved during the life of a scaffold, as agreed between the user and the scaffold erector.

Plan brace is a brace in a horizontal plane.

Raker is an inclined load-bearing tube.

Reveal pin is a fitting used for tightening a reveal tube between two opposing surfaces.

Reveal tie is the assembly of a reveal tube with wedges or screwed fittings, and pads, if required, fixed between opposing faces of an opening in a wall together with the tie tube.

Reveal tube is a tube fixed by means of a threaded fitting or by wedging between two opposite surfaces of a structure, e.g. between two window reveals, to form an anchor to which the scaffold may be tied.

Scaffold board is a softwood board, in accordance with BS 2482:2009, used to provide access, working platforms and protective components such as toe-boards on a scaffold.

Sole board is a timber, concrete or metal spreader used to distribute the load from a standard or base plate to the ground.

Spigot is an internal fitting to join one tube to another coaxially (see also *Joint pin*).

Spigot pin is a pin placed transversely through the spigot and the scaffold tube to prevent the two from coming apart.

Supplementary coupler is a coupler added to a joint to back up the main coupler taking the load when the estimated load on the joint is more than the safe working load of the main coupler.

Sway transom is a transom extended inwards in contact with a reveal or the side of a column to prevent the scaffold moving sideways.

I. Introduction

Through tie is a tie assembly through a window or other opening in a wall.

Toe-board is an up-stand at the edge of a platform, intended to prevent materials or people's feet from slipping off the platform.

1.9.4 Definitions in Safety, Health and Welfare at Work (General Application) Regulations 2007-2016, Part 4: Work at Height

Access and **egress** include ascent and descent.

Fragile surface means a surface, including fittings that would be liable to fail if a person's weight were to be applied to, it in reasonably foreseeable circumstances.

Ladder includes any fixed ladder – timber or metal.

Line includes rope, chain or webbing.

Personal fall protection system means:

- (a) a fall prevention, work restraint, work positioning, fall arrest or rescue system, other than a system in which the only safeguards are collective safeguards, or
- (b) rope access and positioning techniques.

Scaffold means any temporary structure, including its supporting components, whether fixed, suspended or mobile, that is used:

- (a) for supporting employees and materials, or
- (b) to gain access to any structure, and includes a working platform, a working stage, a gangway, a run and a ladder or stepladder (other than an independent ladder or stepladder that does not form part of such a structure), together with any guard-rail, toe-board or other such safeguard and all fixings thereon, but does not include:
 - (i) lifting equipment, or

- (ii) a structure used only to support another structure or equipment (including lifting equipment), and "scaffolding" shall be construed accordingly.

Supporting structure means any structure used to support a working platform and includes any plant used for that purpose.

Work at height means work in any place, including a place:

- (a) in the course of obtaining access to or egress from any place, except by a staircase in a permanent place of work, or
- (b) at or below ground level, from which, if measures required by this Part were not taken, an employee could fall a distance liable to cause personal injury and any reference to carrying out work at height includes obtaining access to or egress from such place while at work.

Work equipment means any machine, appliance, apparatus, tool or installation for use at work (whether exclusively or not) and includes anything to which Regulations 101 to 114 apply.

Working platform means any platform used as a place of work or as a means of access to or egress from a place of work, including any scaffold, suspended scaffold, cradle, mobile platform, trestle, gangway, gantry and stairway that is so used.

2. Management and Control of Scaffolding

2.1 Management of Scaffolding Activities

NOTE

Maintaining scaffolding in a safe condition requires active management

The high rates of activity and change on construction sites, together with the high level of risk associated with scaffolding work, require a correspondingly high level of safety management to prevent accidents and ill health. The five steps listed in this section provide a practical template for the systematic management of scaffolding operations.



Figure 4: Scaffolding Management

All scaffolding must be erected in accordance with a design. For standard proprietary system scaffolds, built in standard configurations, it would be sufficient to use the appropriate designs developed by the system manufacturer for those configurations. Other recognised designs, e.g. such as provided for in TG20 for tube and fitting scaffolds, may also be appropriate to use provided they are appropriate to the scaffolding being erected. For scaffolds that fall outside the scope of these standard designs, a bespoke design will be required. If a bespoke design is required (see Section 2.3.2), then a competent scaffold designer must be engaged to design the scaffold. Where it is reasonably foreseeable, the project designer should identify the need for a bespoke scaffolding at the design phase of the project. The project supervisor for the design process (PSDP) should co-ordinate this scaffold design with the permanent works design team.



2. Management and Control of Scaffolding

Step 1

Scaffolding Policy

Contractor

The contractor should define a policy in relation to scaffolding. This written scaffolding policy should:

- include a commitment to put measures in place to protect employees, other people at work and members of the public from the risks associated with scaffolding;
- require that competent people be employed to erect, maintain and dismantle scaffolds;
- include a commitment to comply with relevant health and safety legislation, including the Safety, Health and Welfare at Work (Construction) Regulations 2013, the Safety, Health and Welfare at Work (General Application) Regulations 2007 and relevant codes of practice and guidelines;

- list who is responsible for choosing the type of scaffold to be used on site and give a procedure for determining the situations where a scaffolding design would be required;
- require that competent people be employed to inspect scaffolds that are in use;
- clearly place the management of scaffolding as a prime responsibility of site management; and
- include a commitment to provide appropriate resources to implement the scaffolding policy.

Step 2

Planning

Contractor

Designer

Scaffolder

The scaffolding erection, use and dismantling stages should be planned to minimise the risks involved.

The written plan should deal with the assembly, use and dismantling of the scaffold. The plan may be in the form of a standard plan supplemented by information on the scaffolding in question. The plan should be kept on site in the Safety and Health Plan.

2. Management and Control of Scaffolding

A copy of the plan, including any instructions it may contain, must be kept available to people concerned in the assembly, use, dismantling or alteration of scaffolding until it has been fully dismantled.

The planning process involves the contractors who will use the scaffolding, the scaffolding designer and the scaffolding erector. The planning process should address the following areas:

- **The relevant legal and other requirements should be identified**

The major legal requirements that apply to scaffolding are included in the Safety, Health and Welfare at Work Act 2005; the Safety, Health and Welfare at Work (Construction) Regulations 2013 and the Safety, Health and Welfare at Work (General Application) Regulations 2007-2016. Where system scaffolds are used, the manufacturer's requirements should be identified and complied with.

- **The job should be defined**

The ground preparation, layout, scheduling, loading, access, tying arrangements and other requirements of the particular job should all be defined by the contractor. The contractor should prepare a contract stating the exact scope of works.

- **Responsibilities should be assigned**

Organisations or individuals with responsibility for performing specific tasks and duties relating to the control of scaffolding should be identified and agreed between the contractor and the scaffold erector.

- **Hazards should be identified**

A hazard is anything that can cause harm. Hazards should be systematically identified for each project. This requirement applies to everyone involved in the scaffolding process, from the contractor requesting the scaffolding to the scaffolding designers and erectors and users of the scaffolds.

- **Risks should be assessed**

When assessing the risks associated with the identified hazards, account should be taken of both

the likelihood of harm occurring and the severity of the resulting injuries (see Section 1.6).

- **Risks should be eliminated or reduced**

Preferred solutions for reducing risks involve collective controls, e.g. protective barriers that protect anybody from falling. Administrative controls, which seek to reduce risk by adherence to instructions or procedures, are less effective. The least preferred solutions rely solely on the use of safety signs and personal protective equipment, e.g. harnesses or safety helmets.

- **The identified hazards and the necessary precautions should be written down**

Precautions to be taken in respect of identified hazards should be written in the safety statement or site-specific amendments to the safety statement and incorporated into the safety and health plan where one is required.

- **Clear performance standards should be set**

The contractor should dictate safety standards on the site. For example, the scaffolding policy could state that all edges will be protected by guard-rails and toe-boards.

- **Site survey**

Where they do not have prior knowledge of the site, a competent person or scaffolder should undertake, on behalf of the scaffolding contractor, a survey of the location where the scaffolding is to be erected. The survey should be carried out before the design or erection of the scaffold and should consider the hazards that exist on site.

- **Recommendations**

Where a scaffolder makes reasonable recommendations to the contractor in relation to the scaffold, the contractor should implement these. If a contractor fails to fully apply the recommendations given by a competent scaffolder, then the contractor may be contravening the requirements of the Safety, Health and Welfare at Work Act 2005.

2. Management and Control of Scaffolding

Written Scaffolding Brief to be Issued to the Scaffolding Contractor (For all scaffolds including manufacturers designs and design scaffolds)

The written scaffolding brief issued to the scaffolding contractor should include:

- Relevant pre-construction information including, where relevant, permanent works drawings, specifications, reports etc.;
- Site location;
- Duty of scaffold including anticipated usage and loads to be carried including the nature of any plant that might be used on it;
- Height and length of the scaffold;
- Duration for scaffolding to be in place and foreseeable modifications required;
- Establish the roles and responsibilities between the contractor and the scaffolder. For example, who will be responsible for arranging the inspection and maintenance of the scaffold;
- Identification of procedures to monitor and co-ordinate the design, erection, modifications, inspections and dismantling of the scaffold;
- The nature of the supporting ground and any supporting structures as far as the contractor is aware;
- The presence of any hidden hazards that might create any unexpected risks to the scaffolding contractor, his or her workforce or other people;
- Whether there is need for a loading bay or specially strengthened portion of the scaffold to receive loads that are placed by mechanical handling equipment or which consist of packaged materials;
- Whether it is anticipated that a specific bespoke design scaffold will be required for the project;
- Whether there is need for temporary cladding and whether grit blasting or similar operations will be carried out;
- Whether the decking should be clear of any lapping boards and whether it should be sheeted over with plywood or similar materials and the necessity to be covered with anti-slip surfaces;
- Whether stair access should be provided instead of ladders (stair access should be provided where it is reasonably practicable to do so);
- The preparation of the “assembly/use/dismantling” plan for the scaffold;
- Whether inside edge protection and toeboards will be required.

2. Management and Control of Scaffolding

Step 3

Implementation

Contractor

Scaffolder

User

The written plan is transformed into action during the implementation stage. Successful implementation requires that the following issues be addressed:

- **Responsibilities**

Individual responsibilities should be clearly communicated by the contractor and the scaffolder. Competent authorised people should be given the authority and resources to carry out their responsibilities and they should be held accountable for their successes or failures in performing their duties.

- **Instruction, training and competence**

Both the contractor and the scaffolder are required to provide information, instruction, training and supervision to their own employees. The instruction and training that is required for design and erection of the scaffolding should be identified by the scaffolding contractor. The instruction and training

that is required for safe use of the scaffolding should be identified by the contractor. In each case, people performing the work should have the appropriate level of competence.

- **Communication**

Relevant information relating to design, scheduling, loading etc. contained in safety statements or the safety and health plan should be communicated to those who need that information. For example, those performing periodic safety inspections need to know the maximum design-imposed load and tie spacing, and those erecting the scaffold need to have copies of the system scaffold erection instructions available.

- **Documentation**

Appropriate documentation must be kept available on site. Such documentation will include safety statements, safety and health plans, scaffolding plans and inspection records, e.g. "Report of results of inspections of Work Equipment for Work at a Height" (see Appendix C). Any defect or issue noted in a scaffolding inspection record must be signed off as rectified when the particular item is attended to and made safe.

Step 4

Checking and Corrective Action

Contractor

Scaffolder

User

Periodic checking is necessary to determine if performance standards are being met and to enable early corrective action to be taken.

SCAFFOLDING MUST BE INSPECTED BY A COMPETENT PERSON:

1

Before it is taken into use

2

Following any modifications (see Section 5.2), exposure to bad weather or periods without use

3

After impact or damage

4

At least every seven days, if scaffolding is higher than 2m and used for construction work

2. Management and Control of Scaffolding

More frequent inspections will be required where there is evidence of recurring deficiencies, unauthorised modification or other circumstances that might affect the strength and stability of the scaffold or where identified as appropriate by a risk assessment.

Where defects are found they should be rectified. The root cause of serious or recurring defects should be identified and corrective action taken to prevent further recurrence.

All scaffolding, regardless of height, must be inspected before first use and after any modifications/alterations or if it has been subjected to adverse weather conditions. Scaffolding must be inspected at suitable intervals thereafter and any working platform 2m or more must also have an inspection by a competent person at least every seven days and records of this inspection must be kept.

Step 5

Reviewing the work

Contractor

Scaffolder

The review stage helps to make each job a learning experience so that the next job can be performed more effectively. The following questions should be asked:

- Was the planning adequate or were there unwelcome surprises?
- Was the implementation adequate so that the job was completed as planned?
- Were the planned checks carried out and did the necessary corrective action take place?
- What changes will be necessary for the next job?

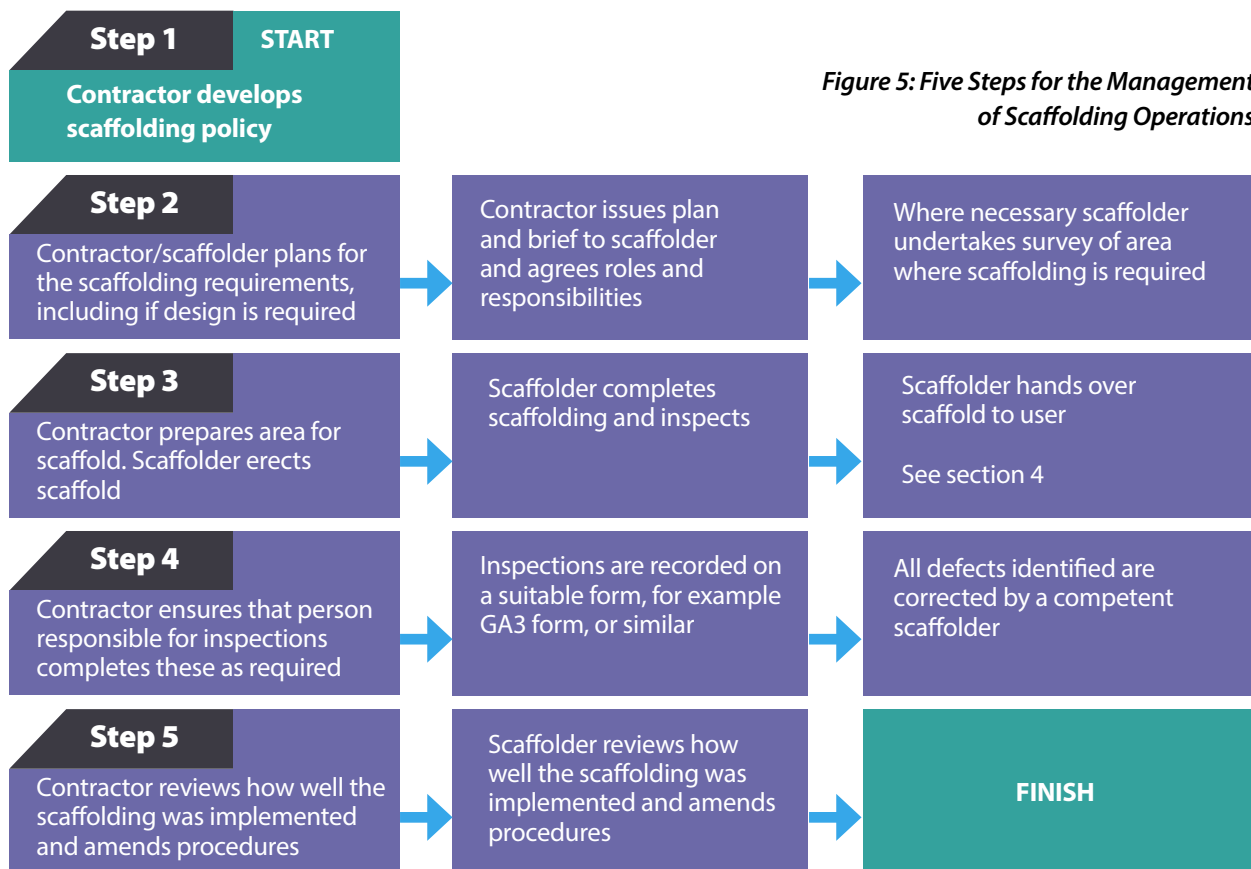

Figure 5: Five Steps for the Management of Scaffolding Operations

2. Management and Control of Scaffolding

2.2 Choice of Scaffolding Equipment

Scaffolding equipment should be selected based on a risk assessment that takes account of the nature of the work to be performed, the loads to be withstood and the height from which falls may occur. The decision may also be affected by the shape of the building; the environment that the scaffolding is to be erected in; the capacity of the foundations; the duration for the scaffolding to remain in place; and the ability to provide ties to the scaffolding.

2.3 Layout and Design

A well laid-out scaffold will require a minimum amount of modification during its life and will be capable of being erected, used and dismantled safely.

2.3.1 Layout

The initial layout will have a significant impact upon the safety of the completed scaffold. When considering the layout, the following points should be considered:

- The scaffold should be laid out to reduce the gap between the structure and the scaffold to a minimum, except where guard-rails will be erected adjacent to the structure.
- The standards should be positioned to avoid manhole lids or shallow drains, which may not be able to sustain the scaffold loading.

2.3.2 Structural Design of Scaffolds

Bespoke drawings, designs and calculations for scaffolding must be prepared for scaffolding unless:

- the scaffolding is to be assembled in conformity with the manufacturer's design, appropriate designs by competent designers or TG20.



WARNING

The designer should have a full working knowledge of I.S. EN 12810 and I.S. EN 12811 and be competent to undertake scaffolding design. Competence is defined as having sufficient training, experience and knowledge appropriate to the nature of the work to be undertaken. The level of expertise required will depend on the complexity of the design. The scaffold design must take account of the relevant technical guidance, manufacturer's instructions and the guidance referenced in Appendix E.

Scaffolding contractors must specify the system of scaffolding in use and provide copies of the manufacturer's guidelines to the contractor and the Project Supervisor for the Construction Stage (PSCS). In some cases, the type of scaffolding used will be dictated by the design.

Where the contractor intends to load materials onto the scaffold by crane or teleporter, loading bays should be incorporated into the scaffolding at appropriate locations. If material must be loaded directly onto the working platform, the risks of overloading or destabilising the scaffold must first be assessed by the contractor and the loading controlled. All other forms of scaffold, including non-standard scaffolds, should be subject to design and calculation by a competent designer.

The need for a specific scaffold design should be identified at the earliest possible time in a project. Where it is foreseeable at design stage that a specific scaffold design will be necessary, the permanent works designer should identify this and flag it to the PSCS/ Contractor, e.g. for a structure with unusual elevations etc. In other circumstances, it may only become evident later in the project that a standard configuration of system scaffold will not suffice.

2. Management and Control of Scaffolding

Once identified as a requirement a competent scaffold designer must be engaged, and a specific temporary works scaffold design produced. The PSDP has a duty to ensure the co-ordination of designs and to ensure co-operation between designers. They must be vigilant to proactively identify any designs, or necessary changes to designs, that may arise during the construction phase of a project.

Sections 6 and 10 of I.S. EN 12811 Part 1, 2004 provide technical data for the structural design of scaffolds.

For illustrative purposes, typical examples where design and calculations may be necessary include:

- sheeted system scaffolds;
- system scaffolds erected in areas where the wind pressure exceeds that specified in I.S. EN 12810 Part 1, 2004 or where the design wind speed exceeds that specified by the scaffolding manufacturer;
- system scaffolds where the maximum height, tie spacing, imposed loads, bay widths or number of working lifts exceeds the manufacturer's recommendations;
- scaffolds where the tie or anchorage capacity is less than 6.1kN (621kg);
- tube and fitting scaffolds where the height exceeds 50m for unsheeted scaffolds and 25m for sheeted scaffolds;
- scaffolds subjected to impact, e.g. mechanical loading of heavy materials onto working platforms;
- scaffolds where the bottom transoms or ledgers have been omitted to allow pedestrian access;
- scaffolds where the first line of ties is more than 4m above the base of the scaffold;
- scaffold buttresses;

- special scaffolds including: loading bays, protection fans, nets, pavement frames, cantilever scaffolds, truss-out scaffolds, free-standing external towers, hoist towers, slung scaffolds, pedestrian bridges and walkways, temporary ramps and elevated roadways, masts, lifting gantries, and temporary buildings and roofs;
- scaffolds where the allowable bearing pressure of the ground may not be adequate to support the scaffold;
- scaffolds that are required to be erected off roofs or other existing structures.

Factors to be considered for a temporary works/scaffold design include the ground conditions (or capacity of other structure supporting the scaffold), requirement for foundations, positions of components, the nature of the connections to other components and the limitations for loading and sequence of operations.

Temporary works should be designed in accordance with recognized engineering principles. The design should consider the variability of materials, workmanship, site conditions and construction tolerances. Temporary works systems should be designed regarding ease and safety of erection and dismantling. Temporary works / scaffold designers and suppliers should provide guidance on the implementation of their designs.

(Please refer to Appendix E for further guidance.)



WARNING

The designer should have a full working knowledge of I.S. EN 12810 and I.S. EN 12811 and be competent to undertake a scaffolding design. Reference should also be made to their relevant guidance listed in Appendix E.

2. Management and Control of Scaffolding

2.3.3 Building Design and Scaffold Erection

The design of the temporary works can be affected by, or can affect, the design of the permanent works. For example, many system scaffolds require that every standard be tied to the structure under construction or to some other substantial structure. The best arrangement is where the ties can be left in place until final dismantling of the scaffold.

The PSDP and the PSCS should, at an early stage, seek the co-operation of building designers/permanent works designer in permitting the attachment of scaffold ties to the building structure where such attachment is reasonably practicable. The PSDP must ensure that temporary works/scaffold designer and scaffolding contractors are provided with the appropriate information, from the permanent works designer, to safely design and erect the scaffolding. This is particularly important when erecting scaffolding on existing permanent structures, slung scaffolds, cantilevered scaffolds, erecting on roofs, over basements etc.

Timely provision of adequate details of the proposed permanent works is necessary to properly schedule the construction of the temporary works. Project supervisors should co-ordinate these matters; for example, they should provide information on the proposed location of adjacent drains or other excavations to the temporary works designer or contractor so that they can ensure that the foundations of the relevant scaffolds are not undermined. Where such information is not received in a timely manner, the project supervisors should ensure that adequate time is allowed for the safe completion of the project.

The permanent works designer must consider the buildability of the structure when developing their design. The overall design should take account of the methods of construction and the space required for the temporary works. The permanent works designer should provide the relevant information – particularly the significant risks involved in its construction. This must be taken account of when any temporary works design is being developed.

The [Guidelines to the Procurement, Design and Management Requirements of the Safety, Health and Welfare at Work \(Construction\) Regulations 2013](#) provides detailed guidance on the roles of the Project Supervisors and on co-ordinating design and construction activities on site. The guide also provides template permanent works and temporary works design certificates which can be used to assist in co-ordinating and recording design information on a project.

2.3.4 Co-ordination of Temporary Work

The legal duty to co-ordinate temporary works/scaffold design is the responsibility of the Project Supervisor for the Design Process (PSDP). The Project Supervisor for the Construction Stage (PSCS) has a legal duty to co-ordinate the construction activities relating to carrying out temporary works and scaffolding.

For larger projects, particularly where the scaffolding will be complex and involve support from the permanent building structure, a Temporary Works Co-ordinator (TWC) should be appointed to assist the Project Supervisors in carrying out their duties. The TWC must be competent to carry out the role and will be responsible for the implementation of the temporary works procedures on site.

A TWC can assist the Project Supervisors in their duties by:

- helping effective communications and co-ordination between the PSDP, designers and the PSCS and relevant contractors in relation to the temporary works;
- ensuring that the organisation's procedure for the control of temporary works is implemented on site;
- assisting in the preparation of the scaffolding design brief;
- ensuring the temporary works design is implemented in accordance with the design;
- co-ordinating the checking and certification of temporary works;

2. Management and Control of Scaffolding

- maintaining a register of drawings, calculations, inspection and certification records and other relevant documentation relating to the temporary works;
- assisting in the communications and co-ordination of any necessary changes to temporary works designs or construction;
- assisting in the planning for the dismantling of temporary works.

BS5975 Code of Practice for falsework provides further information on TWCs.

2.4 Erection Scheduling

Proper scheduling of activities is necessary to ensure that the scaffold is available and safe to use when it is needed and that the activities of an individual trade do not endanger the scaffold or the users of the scaffold. The following scheduling issues should be considered:

- Where scaffolds are providing edge protection, e.g. during formwork erection or block laying at the edges of concrete floor slabs, the platform should be maintained as close as practicable to the working level.
- Where movable ties are provided, replacement ties should be installed before existing ties are removed to facilitate plasterers, glaziers or other trades.
- The particular needs of scaffold users or specific trades should be determined in advance so that adequate scaffolding provision can be made before they commence working.
- Adjacent excavations, which could undermine the scaffold foundation, should be back-filled and compacted before scaffold erection or the excavations should be deferred until after the scaffold has been dismantled.

2.5 Planning for Use and Maintenance

A scaffold rarely stays the same between initial erection and final dismantling. There is therefore a need to plan how the scaffold will be modified, inspected and maintained. The following issues should be considered when planning for use and maintenance:

- The needs of different trades working on the scaffold. Imposed loads, scheduling (painters, plasterers and bricklayers work at significantly different rates), cantilever brackets, adjustments to ties and guard-rails etc. should be identified and provision made to meet these needs before the work is planned to start.
- A competent scaffolder with responsibility for modifying, inspecting and maintaining the scaffold should be appointed.
- An adequate number of competent scaffolders should be available to the site to allow modifications to be made in good time. The full-time attendance of at least one competent scaffolder may be required on sites where modifications are likely to be frequent.
- The restrictions on imposed loads and unauthorised modifications to the scaffold should be communicated to users. The contact person for complaints or requests for scaffolding modifications should be identified. This should be done as part of the normal health and safety induction, which everybody on site should receive.

2.6 Information to Purchasers or Hirers of Scaffolding Equipment

The manufacturers and suppliers of system scaffolds and components have a duty to supply information to the purchaser. People supplying system scaffolds and components for hire or lease also have a duty to supply information to the hirer or lessee.

2. Management and Control of Scaffolding

The information should include the use for which the scaffold has been designed or tested, and any information necessary to ensure that the scaffolding may be erected, dismantled and used safely. The supplier should provide a complete set of instructions that are sufficient to ensure the safe erection, use and dismantling of the scaffold.

Scaffolding contractors must specify the system of scaffolding in use and provide copies of the manufacturer's guidelines to the contractor and the PSCS/PSDP where required. These manufacturer's guidelines must be comprehensive and product specific and must provide all the necessary information and performance data necessary for the designer and scaffolder to carry out their work in a safe manner.

- limitations of use including safe working loads and, in particular, reduced loadings on hop up brackets;
- any unusual conditions that can be foreseen; and
- any conclusions to be drawn from experience of using the type of scaffold equipment.

The information provided should be comprehensible to the workers concerned.

2.7 Information to Users of Scaffolding Equipment

Workers should receive sufficient and, if appropriate, written information on the scaffold equipment, including safety and health information on:

- conditions for use of the equipment, including instructions for its safe use;



3. Erection of Scaffolds

3.1 Safe Erection and Dismantling

i NOTE

Scaffolding should be erected and dismantled so that the risks to the scaffolders, other workers and the public are eliminated or minimised.

3.1.1 Safety of Scaffolders

The major life-threatening hazards facing scaffolders are the risk of falls from a height, falling scaffold components and contact with overhead electric lines.

The scaffolding contractor should carry out a risk assessment relating to the type of scaffolding operations to be conducted at the site. The safety statement and risk assessment of the scaffold erection contractor and, where appropriate, the site safety and health plan should identify the hazards that erecting a scaffold on the site is likely to present and specify the necessary precautions.

The Safety, Health and Welfare at Work (Construction) Regulations 2013 and the Safety, Health and Welfare at Work (General Application) Regulations 2007-2016 require people at work to be protected from the danger of falling, either by the provision and use of collective safeguards such as adequate working platforms and guard-rails or, where this is not practicable, by the provision and use of safety nets or personal protective equipment such as suitable fall arrest systems (incorporating safety harnesses, lanyards and anchorages).

The General Principles of Prevention (see Section 1.6, Table 1) set out the hierarchy of control measures that designers, contractors and employers should implement.

Collective safeguards should be specified in the risk assessment and/or safety and health plan. These will normally include, where possible, the use of ladders or stairs and the placing of decking and guard-rails on each platform before scaffolders go onto it or else as soon as practicable.



3. Erection of Scaffolds

Collective protection of scaffolders must be prioritised over personal protection. Where practicable the use of scaffold step systems, advanced guard rail systems and/or other similar collective protective measures must be used to help eliminate risks to the scaffolder.

Where the necessary collective safeguards will be inadequate during certain phases of the work, personal protective equipment, e.g. nets, fall arrest and/or restraint systems, should be used to supplement the collective safeguards.

Construction of certain scaffold types or construction work that includes certain activities may present difficulties in providing collective safeguards throughout all phases of the work. Such work will normally require the supplementary use of personal protective equipment, including the fixing of anchorages, until collective safeguards become adequate. Examples of such work include:

- cantilever loading bays,
- cantilever scaffolds,
- truss-out scaffolds,
- slung scaffolds,
- protection fans and nets,
- bridges and walkways,
- work on temporary buildings and roofs,
- fragile roof work,
- work in confined spaces such as sewers, deep excavations, lift wells and shafts, deep basements or sumps, where rescue may be required, and
- work out of integrated person baskets or mobile elevated working platforms.

When work at height is carried out over or near water then a site-specific risk assessment must be carried out by a competent person. Factors such as water depth, tide changes, water flow and flood risks must be considered.

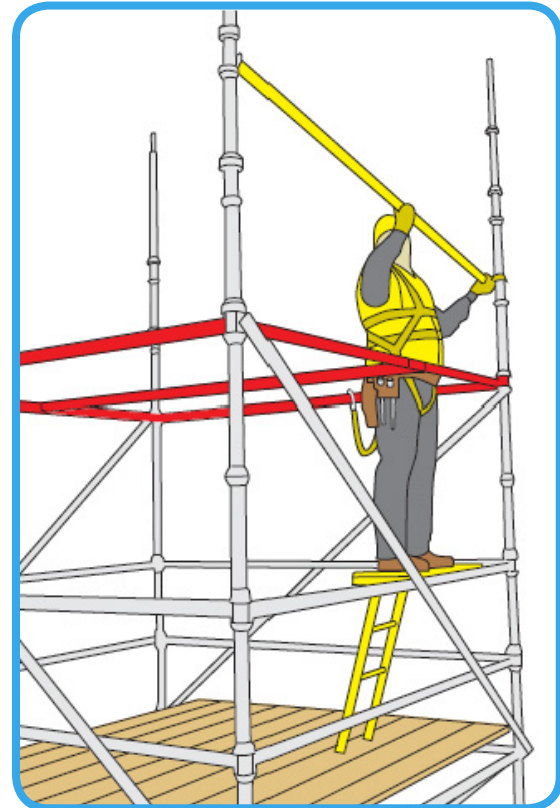

Figure 6: Scaffolder Installing a Guardrail in Advance to the Next Lift from a Scaffolder's Step (From SG4:15)

Employers must identify whether the greater risk of injury to the worker(s) is from falling from a height off the working platform or from drowning if the worker(s) or the platform falls into the water. The decision can then be made as to whether it is more appropriate to wear a suitable harness to address the fall risk or whether the risk of drowning would render the use of a harness unsafe. If the risk assessment determines there is a greater risk of drowning, then appropriate life jackets/personal flotation devices should be worn and not harnesses. In this case any risk from fall from height should be controlled by means other than the use of harnesses. An appropriate rescue plan must be in place for all work at height and work over or near water.

3. Erection of Scaffolds

Where personal protective equipment is to be used, the contractor should specify in the safety statement, and the PSCS should incorporate into the safety and health plan, the means of personal protection, how it is to be used, the means of attachment and the rescue procedures. The contractor should provide adequate training, instruction and supervision to ensure that the personal protective equipment is used properly at all relevant times.

(The references provided in Appendix E offer further guidance on working at height.)

3.1.2 Safety of Other Workers and People

Other workers or members of the public may be placed at risk during the erection of scaffolding, including from the accidental dropping of tools or scaffolding components. Adequate precautions, including suitable exclusion zones as identified by risk assessment, should be taken to eliminate or reduce the risk.

Other workers should be effectively excluded from the work areas by signs and/or solid barriers. Solid barriers or hoarding should be used to exclude members of the public from the area. Where people cannot be excluded from the working area, or adjacent to the work area, they must be protected by the provision of properly designed and constructed crash decks or fans.

3.1.3 Incomplete Scaffolding

A scaffold should be constructed so that it is left complete and is properly tied, braced and decked and has adequate guard-rails and toe-boards. Where a scaffold is left incomplete, there is a risk that it will be used while it is in a dangerous condition. Where scaffolds are being used at a place to which the public has access, such as footpath scaffolds, effective precautions must be in place to prevent people climbing the scaffolding.

Where a scaffold is partly erected or dismantled, a prominent warning notice should be placed at each potential access point and barriers should be placed to

prevent access. Such notices should be removed when they are no longer required.

The most effective way of preventing access to an incomplete scaffold is by removing all decking and ladders. Incomplete scaffolds should be completed or dismantled as soon as practicable. Where scaffolds are being used at a place to which the public have access, such as footpath scaffolds, effective precautions must be in place to prevent people from climbing the standards.

3.2 Materials

3.2.1 Scaffolding Provider's Inspection Prior to Use

Scaffolding materials should be inspected by the scaffolding provider prior to their use on site. This inspection can be carried out before the materials are delivered to the site. An area should be set aside for damaged or defective materials.

Signs should be erected indicating that the material is defective and is not to be used. A checklist is provided in Appendix B (Checklist 1: *Inspection of Scaffolding Materials Before Use*) to assist this examination.

If it is determined during the erection of the scaffold that an element is defective, the scaffolder should put this defective part to the side and not incorporate it into the scaffolding.

3.2.2 Standards

Standards are upright members that transmit the vertical loads of the scaffold to the foundations. The spacing of system scaffolding standards should follow the recommendations in the manufacturer's erection instructions.

(For tube and fitting scaffolds, the service loads for working areas is provided in Table A1 in Appendix A.)

3. Erection of Scaffolds

3.2.3 Transoms

Transoms are horizontal members normally in the direction of the smaller dimensions of the working scaffold. Intermediate transoms may be required to support the scaffold platform between main transoms.

The lowest transom should be installed as close as possible to the bottom of the standards, otherwise the load-carrying capacity of the scaffold will be significantly reduced. The bottom transom is sometimes omitted to permit pedestrians to walk through the scaffold; however, in this event the scaffolding must be designed to reflect the omitted transom. Alternatively, the risk assessment and safety and health plan may indicate other solutions, such as erection of a protective hoarding outside the scaffold.

3.2.4 Ledgers

Ledgers are horizontal members normally in the direction of the larger dimension of the working scaffold. Ledgers also support any intermediate transoms. The load-carrying capacity of the scaffold will be significantly reduced where it is not possible to place the first ledger at the base of the standards (see Section 3.2.3).

3.2.5 Couplers

Couplers are devices used to connect two tubes. Couplers are used in conjunction with system scaffolds mainly for the attachment of ties, plan bracing and cross (ledger) bracing. The proper use of appropriate couplers is therefore important to the stability of the scaffold. Couplers, when new, should comply with the requirements of the relevant European standard.

I.S. EN 74 Part 1, 2005: *Couplers, spigot pins and baseplates for use in falsework and scaffolds – Part 1: Couplers for tubes – Requirements and test procedures* specifies four classes of couplers (see Table A3 in Appendix A).

The characteristic values of the resistances for couplers/ safe working loads are listed in Table A4 in Appendix A.

These values only apply to couplers marked with EN 74 and, where appropriate, 'A' or 'B'.

3.3 Stability

A scaffold is a temporary structure that is subjected to a wide range of loading during erection, use and dismantling. It should support its own dead load; live loads from construction materials, workers and tools; dynamic loads from material placement; and wind loads. Overloading and misuse of scaffolding can lead to scaffolding collapses. The manufacturer's instructions should always be referenced when determining the safe working loads or working platforms.



WARNING

Common faults include:

- ✘ poor foundations;
- ✘ inadequate tying and bracing;
- ✘ overloading; and
- ✘ the removal of ties and bracing.

Scaffold stability depends on carefully following the system scaffold manufacturer's instructions and the provisions of this Code or other equivalent standards. In particular, the following issues should be addressed:

- the foundations should be adequate (see Section 3.3.1);
- the scaffold should be tied to the permanent structure or to buttresses (see Section 3.3.2);
- the scaffold should be braced (see Section 3.3.4); and
- the scaffold should not be overloaded (see Section 3.8).

3. Erection of Scaffolds

3.3.1 Foundations

The foundations of a scaffold should be adequate to support the load imposed by each standard and the scaffold as a whole throughout the life of the scaffold.

3.3.1.1 Ground Surfaces

- **Concrete and steel surfaces**

Metal base plates should be used on concrete or steel surfaces of adequate bearing capacity.

- **Other surfaces**

Metal base plates should be used where there is a hard asphalt or similar surface with sufficient bearing capacity. Where the bearing surface is soil, compacted gravel, tarmacadam, hardcore, paving slabs or similar, sole boards of timber or another suitable material should be used. Where the surface has been disturbed or back-filled, or is soft, then stone should be provided, and it should be compacted.

- **Supported of existing structures, including roofs**

The PSDP must ensure the temporary works designer and the scaffolder are provided with the necessary information, from the permanent works designer, with regard to the existing structure/the structure under construction with regard to its capacity to support a scaffold.

The contractor should prepare the ground in advance of the scaffolding being erected. The contractor should give the scaffolder written confirmation that the bearing pressure of the ground is sufficient for the scaffolding being erected. Guidance on allowable bearing pressures for various soils and fill materials is given in BS 5975:2008+A1:2011 Code of Practice for temporary works procedures and the permissible stress design of falsework.

3.3.1.2 Sole Boards

Where practicable, timber sole boards should support two standards. A timber sole board under any one standard should be at least 35mm thick, at least 220mm wide and 1,000cm² in area (e.g. 220mm

wide by 500mm long). Larger sole boards (minimum 1,700cm², e.g. 220mm wide by 775mm long) should be used where the ground is soft or disturbed. Previously used sole boards should never be used as scaffold boards, they should be marked so that they are readily distinguishable, e.g. the ends should be cut at an angle.

3.3.1.3 Base Plates

Base plates should be placed on the centre of sole boards and not less than 150mm from either end. Adjustable base plates incorporate screw jacks to allow the scaffold to be easily levelled: they should not be extended beyond the manufacturer's recommendations.

3.3.1.4 Sloping Foundations

Many scaffolds are erected on sloping surfaces, e.g. footpaths and roadways. Using normal base jacks on such surfaces may induce bending in the bottom standards and reduce the loading capacity of the scaffold. Base plates that permit adequate rotation should be used or other measures should be taken to ensure that the capacity of the standards is adequate to sustain the design loads.

Special precautions may be necessary to ensure the stability of the scaffold where the ground slope exceeds 1 vertical to 10 horizontal.

3.3.1.5 Adjacent Excavations and Underground Services

Scaffolds should not be erected close to the edge of open excavations, and excavations should not be made close to the scaffold in a manner likely to undermine the stability of the scaffold. Scaffold standards should not be erected over shallow drains or manhole covers unless adequate arrangements have been made to carry the load over them.

Where excavations will affect only one standard, the load may be transferred to adjacent standards by using proprietary beams or A-frames. The adjoining standards should not be overloaded. Extra standards may also need to be installed to provide additional support.

3. Erection of Scaffolds

3.3.1.6 Blocks, Bricks and Other Materials

Loose blocks or bricks or similar materials should not be used to support scaffold standards as they may split, slip out or fall over. Adjustable base plates, with sole boards as required, should be used instead of such materials.

3.3.2 Ties

General

Ties connect the scaffold to the structure being built. Ties perform a dual function:

- they stabilise the entire scaffold to prevent it from falling towards or away from the building; and
- they stabilise the individual scaffold standards to prevent them from buckling. As the load on a scaffold increases, more ties may be needed to prevent the standards from buckling.

There are several different tie types. Those types of tie that are non-movable should be chosen, where reasonably practicable, as they present fewer difficulties with maintenance or interference. Non-movable ties are assumed to be cast or drilled into the structure and will not need to be moved until final dismantling of the scaffold.



WARNING

Scaffolding fitted with debris netting or sheeting requires additional ties. Refer to the manufacturer's erection manual and verify that the ties are installed as per these recommendations before the debris netting or sheeting is installed onto the scaffolding.

Ties should resist movement towards the building and away from the building. Where a tie cannot resist movement towards the building, e.g. through ties, long bolts and wire ties, the tie should be

supplemented by other measures, e.g. tubes butted against the building.

Ties should be securely coupled to both standards or to both ledgers, in accordance with the manufacturers recommendations, and be as near to a node point as possible. Where ties are attached to the ledgers, they should be attached not more than 300mm from a standard. Where this hinders access along a working platform, attachment to the inside ledger or standard only is permissible.

System scaffold manufacturers may have different requirements relating to the maximum distance of ties from standards and node points. Where it is not possible to meet these distances, the manufacturer may permit plan bracing to be installed between the tie and the standards.

The vertical interval between ties should be determined in the scaffolding design and communicated to the scaffolding erector. In the case of system scaffolds, reference should be made to the manufacturer's instructions.

Scaffolds of normal width of 1.25m should not be erected higher than the manufacturer's instructions and to a maximum of 4m higher than the highest line of ties, unless to a specific design.

3. Erection of Scaffolds

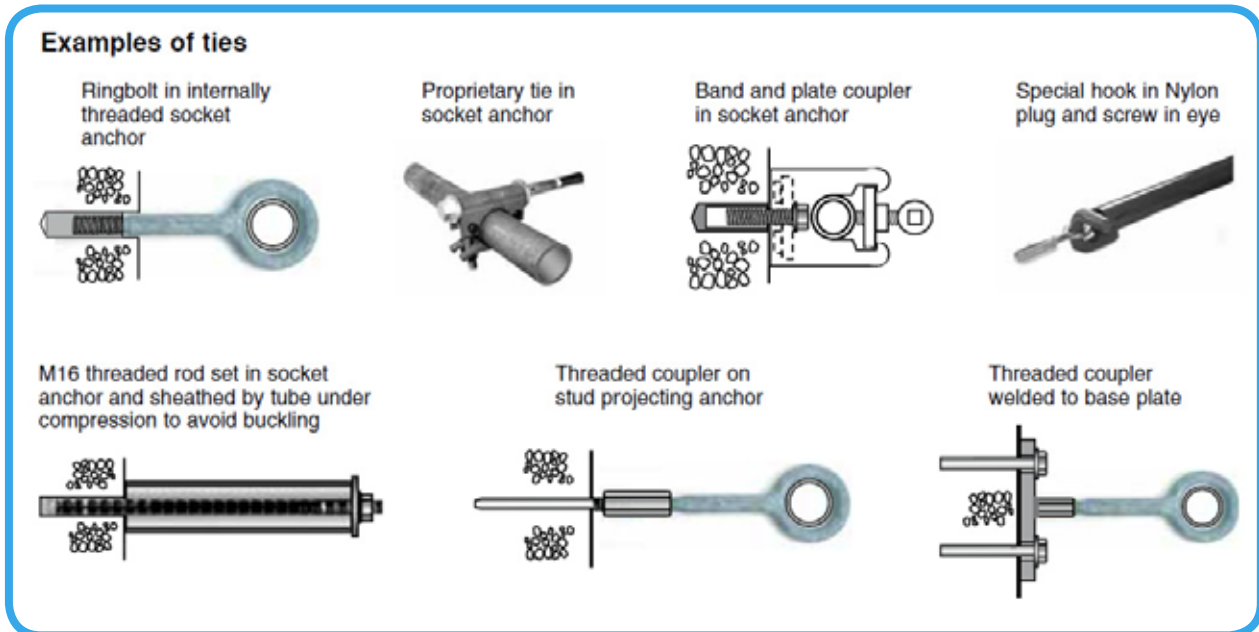

Figure 7: Examples of Different Types of Ties (from NASC TG4:11)

3.3.2.1 Cast-in and Drilled Anchorages

Detailed guidance on the safe design and installation of anchors for safety critical situations is contained in the [Code of Practice for Design and Installation of Anchors](#). Further guidance is available in NASC TG4:11 'Anchorage systems for scaffolding'.

Where lateral support is to be provided by the structure served, both the structural adequacy of that structure and the attachment of the anchorages shall be verified. If the base material is too weak to support an anchor, or if the whole structure is too weak, other means of access should be considered, including free-standing designed scaffolds or mobile elevated work platforms (MEWP).

These anchorages, which are cast or drilled into the permanent structure, can usually be left in place until the scaffold is being

dismantled. They are not subject to the degree of interference associated with, for example, through ties. These anchorages and their components should have a safe working capacity of at least 6.1kN (637kg) in both tension and compression. TG20 allows for the use of ties with a lower capacity under certain circumstances for 'light use' only (as set out in the standard). It may be possible for a **competent person**, in circumstances where it is not possible to attain 6.1kN or greater, to complete design calculations for ties of lesser capacity and identify additional tie points to give an overall effective tie in, using the lower capacity tie, as would be the case with ties of 6.1kN arranged in a standard configuration. (See TG4:17 Anchorage systems for scaffolding.)

3. Erection of Scaffolds

Workers installing anchorages should be instructed in the manufacturer's recommendations for each type of anchorage and these recommendations should be strictly complied with.

The anchorage capacity should be established by either proof load testing or by testing to failure a representative sample of anchorages. The manufacturer's recommendations in relation to the safe working capacity for your base material and testing should be followed.

Testing should be carried out on all projects.

A sample of anchors to be used shall be tested to a load of 1.5 times the required tensile load (or as may be directed by the anchor manufacturer). In the case of ties requiring 6.1kN tensile capacity, this means a test load of 9.2kN (where a tie load of 12.2kN is required the proof load equals 18.3kN). It is assumed that the allowable load of the anchor is in all cases greater than or equal to the working load. The pass criterion is that no significant movement of the anchor is apparent; a visual check is sufficient.

A minimum of three anchors shall be tested and at least 5% (1 in 20) of the total job (see Table 2). If any anchors fail to satisfy this test requirement then the reason for failure should be investigated and the rate of proof testing at least doubled, i.e. at least six tests and one in ten overall.

If significant numbers of anchors fail this test, then the overall safety margin is in doubt and the specification and installation method should be reviewed before the scaffold is passed for use.

Site tests should be carried out by suitably competent personnel (other than the actual installer of the fixings tested) using a test meter with a gauge calibrated within the last twelve months to an accuracy of >95%. Test equipment should apply the load through suitable couplers and be arranged such that the reaction loads are taken sufficiently far from the anchor so as not to influence the result, typically this means ensuring the feet of the bridge do not rest on the masonry unit being tested.

Table 2: Number of Proof Tests of Anchorages Used for Scaffold Ties

Total ties on the job	Number of proof tests
0 - 60	3 tests
61 - 100	5 tests
101 - 120	6 tests
121 - 140	7 tests
141 - 160	8 tests
161 - 180	9 tests
181 - 200	10 tests
201 - 220	11 tests
221 - 240	12 tests

i NOTE

Test certificates / results for anchorages should be attached to the Scaffolding Handover Certificate

Source: Construction Fixings Association and the National Access and Scaffolding confederation - TG4 : 2004

3. Erection of Scaffolds

Most cavity walls, cladding panels and many parapets and other architectural features will be unsuitable for the attachment of anchorages. Where refurbishment work is being undertaken, the capacity of the building fabric to withstand the anchorage loads should be assessed.

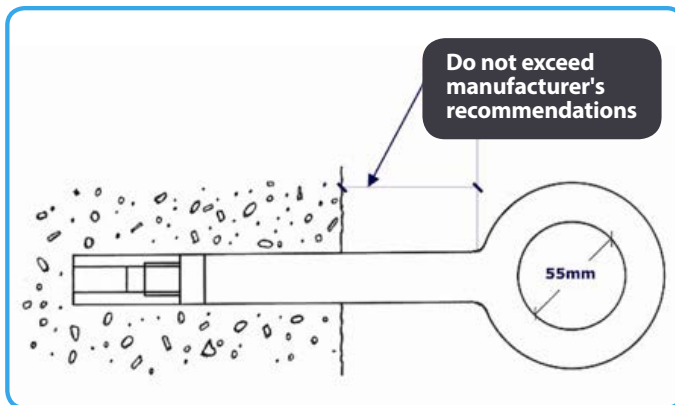

Figure 8: Typical Ring Bolt Anchorage

A ring bolt may be used by passing a scaffold tube through the ring and connecting it to the scaffold.

The exposed length of ring-bolt shank or other bolts should be kept short and it should not be extended beyond what is permitted in the manufacturer's written recommendations for bolts in compression. Where no written recommendations are available, the capacity of the tie in compression should be established by testing.

3.3.2.2 Through Ties

Through ties are attached to a tube across the inside and outside of an opening such as a window. It is preferred that this tube be vertical to prevent slipping and damage caused by workers standing on the tube and that the tie tube rests on or just above the lintel and close to the nearest standard. Other arrangements may be used where this is not practical. The inside tube should be supplemented by an outside tube or by a butting tube.

3.3.2.3 Reveal Ties

Reveal ties may be used where it is impractical to bolt into the fabric of the building or through open windows. These ties rely on friction and consequently require frequent inspection to ensure that the friction is maintained. Timber packing should be

used, of approximately 10mm thickness (to minimise shrinkage), alternatively 9mm or 18mm plywood may be used. The end plates of the tube should be expanded onto the reveals by tightening a nut on the reveal pin. The tie tube should be fixed to the reveal tube not more than 150mm from the reveal and at the opposite end from the reveal pin.

Where reveal ties are used, a greater number of ties are required. Where practicable, no more than 50% reveal ties should be used unless in accordance with the requirements of a bespoke design scaffold specification.

i NOTE

Reveal ties are not suitable for use on sheeted scaffolds.

The use of base jacks instead of a reveal tie is not acceptable. Due to the difference in the thread used in base jacks they are susceptible to being loosened by vibration, this is of concern where motor vehicle traffic is passing near the site.

3. Erection of Scaffolds

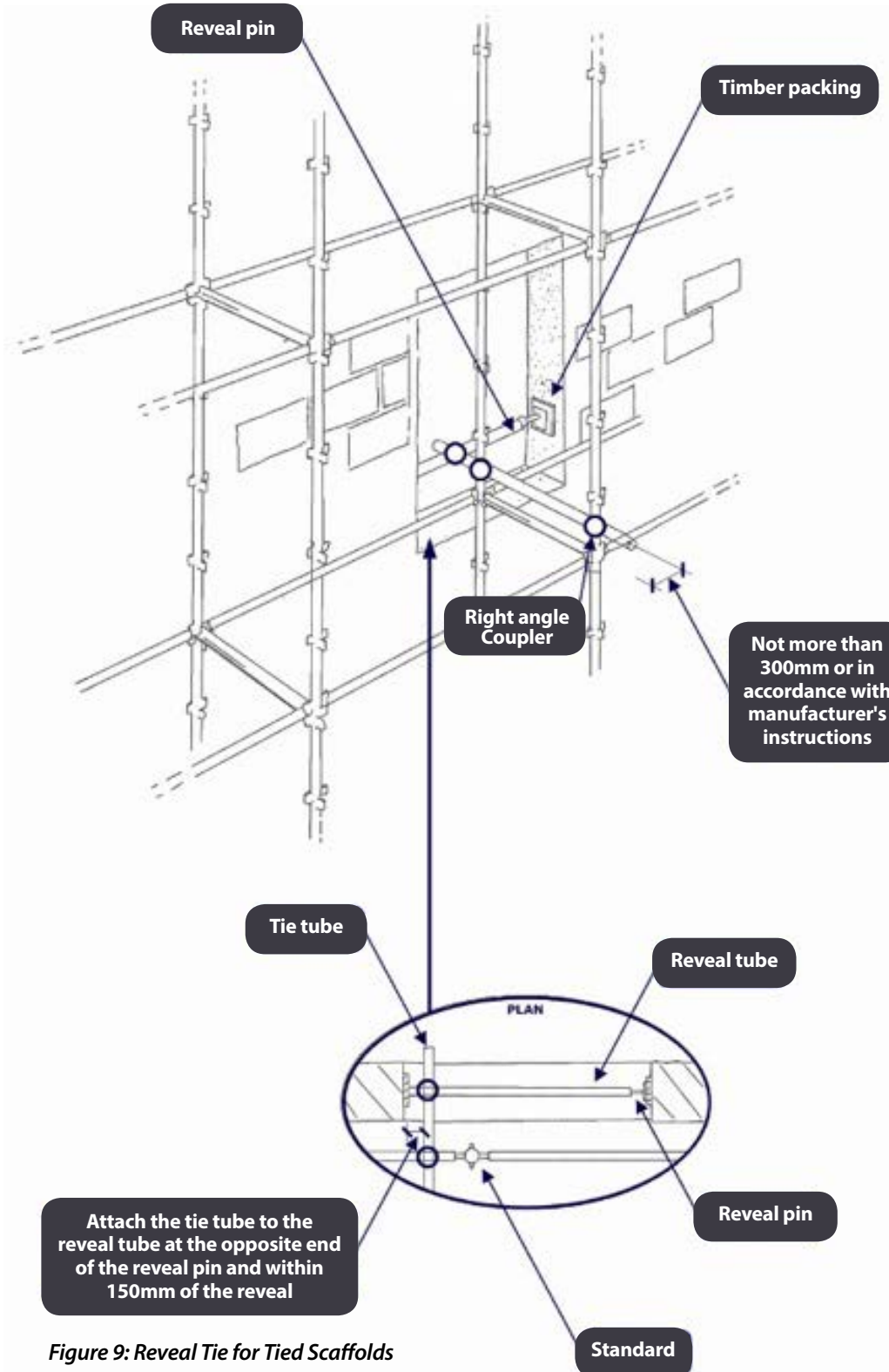

Figure 9: Reveal Tie for Tied Scaffolds

3. Erection of Scaffolds

3.3.2.4 Returns

Where a system scaffold is continually and correctly returned around the corner of a building, it can be regarded as being equal to a tie to the first pair of standards in each direction from the quoin (e.g. the ties can commence from the second pair of standards back from the return). It should be noted that if a correct and continuous return is not in place, then each elevation should be regarded as separate and must then be tied at each end. Plan bracing would be required to provide tying to adjacent standards.

Returns of tube and fitting scaffolds may be regarded as providing attachment of the scaffold to the façade for a 3m length measured from the end of the building.

3.3.2.5 Structurally Designed Buttresses

Structurally designed buttresses provide tying to those system scaffolding standards directly connected to the buttresses. Plan bracing is required to provide tying to adjacent system standards. Buttresses connected to tube and fitting scaffolding may be regarded as providing attachment of the scaffold to the facade for a 3m length measured from each side of the buttress.

3.3.2.6 Single Unjointed Raking Tubes

Single unjointed raking tubes coupled to the scaffold at a maximum of 6m intervals and tied back to the scaffold at the foot may be considered as providing adequate stability in the direction of the raker for scaffolds up to 6m high. The tube should be at an angle of not more than 2 vertical to 1 horizontal and not more than 6m in length.

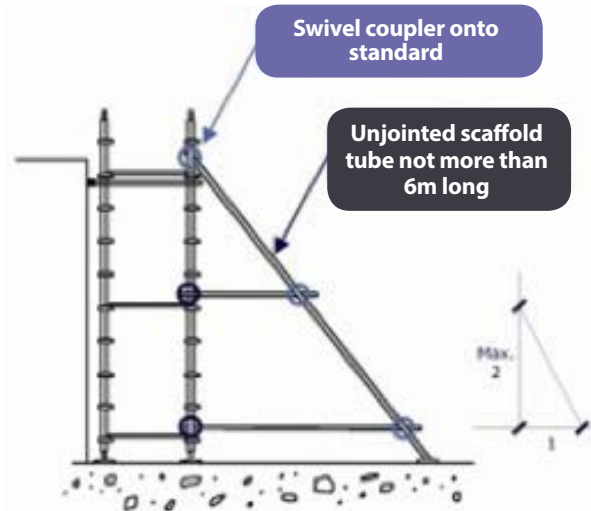

Figure 10: Stabilising a Scaffold Less than 6m High – Raking Tubes

(please refer to manufacturer's instructions)

3.3.3 Tie Spacing

The spacing of ties is determined mainly by the loading and layout of the scaffold. As the loading, height, number of working platforms or number of boarded platforms or the wind loading increases, so does the number of ties required. The system manufacturer's instructions for tie spacing should be followed; for tube and fitting scaffolds, the spacing of the ties determined by the designer must be followed.

3.3.3.1 System Scaffold Ties

Each type of system scaffold has a characteristic tying pattern recommended by the manufacturer. These patterns should be followed unless structural design calculations show any proposed variations to be safe. The system scaffolding manufacturer's recommended tying arrangements should be available to the scaffolders. The recommended tying arrangements should also be provided to the people responsible for inspecting the system scaffold during use.

3. Erection of Scaffolds

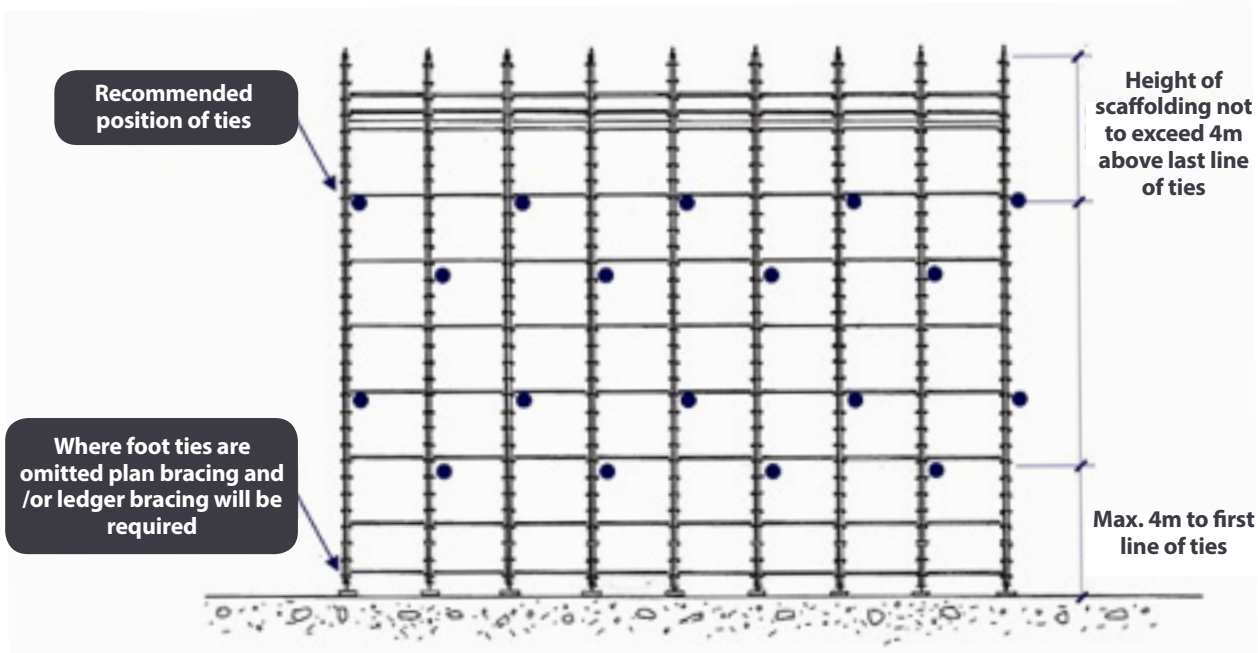

Figure 11: Example of a Tie Pattern for a Lightly Loaded Scaffold
(please refer to manufacturer's instructions)

Many system scaffolds require every standard to be tied and for the first level of ties to be no more than 4m above the base plate. Where this is required but is not possible for an individual standard, the manufacturer may permit plan or cross bracing to be provided between ties to give stability to the untied standard. Such bracing will transfer more load to the existing ties, these ties should be able to resist the increased loading and at least two couplers should provide restraint in each direction at both the scaffold and the wall end of the tie. The ties must be tested to ensure they can facilitate the extra loading.

3.3.3.2 Tube and Fitting Scaffold Ties

The number of ties must be determined by the designer, in accordance with the requirements of I.S. EN 12811 Part 1, 2004. Guidance on ties is also available in TG20. When tying sheeted scaffolds, the top lift must be tied.

In addition, ensure that the coupler capacity is adequate and that there are at least two couplers providing restraint in each direction at both the scaffold and the wall end of the tie.

3.3.4 Bracing

Bracing is required to stiffen the scaffold and prevent it from swaying. In system scaffolds swaying can cause instability, weld deterioration and can over-stress the standards. Refer to the manufacturer's erection manual for specific requirements for bracing.

In tube and fitting scaffolds, each plane of the scaffold should be braced by installing diagonal tubes that divide it into a complete series of triangles from the bottom to the top of the scaffold. The braces should be fixed as close as possible to the standard–ledger intersections. (Refer to Table A4 in Appendix A for the characteristic values of the resistances for couplers.)

3. Erection of Scaffolds

3.3.4.1 Façade Bracing

Façade bracing runs parallel to the building and examples include:

- (A) a series of parallel diagonal tubes placed one above the other;
- (B) in long façades, a continuous diagonal tube from bottom to top; or
- (C) a zigzag pattern (for scaffolds with a maximum of four lifts).

The scaffold should incorporate one type of façade bracing (see Figure 12).

System scaffolding should be braced in accordance with the manufacturer's recommendations. The recommended maximum façade brace spacing for system scaffolds ranges from three unbraced bays to eight unbraced bays; however, this depends on the system used and the manufacturer's erection manual must be referred to.

Tube and fitting scaffolds should be braced at least every six bays, unless movement along the building is prevented by other means.

Bracing should be fixed as near to the standard-ledger intersections as possible. The bracing should extend to the bottom of the scaffold with no breaks. This applies to all scaffolds including pavement scaffolds.

Façade bracing must continue to the bottom of the scaffold.

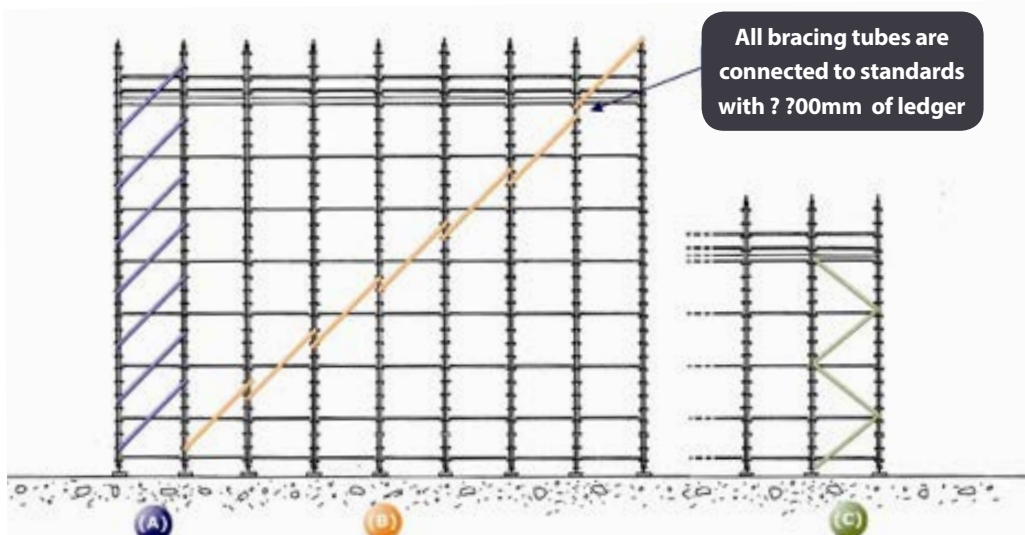

Figure 12: Examples of Façade Bracing (use A or B or C as appropriate – do not mix bracing types)

3. Erection of Scaffolds

3.3.4.2 Ledger Bracing

Ledger or cross bracing runs at right angles to the façade and is in a vertical plane. Some types of system scaffold do not require cross bracing unless:

- ties cannot be located as required by the manufacturer or are liable to be removed; or
- the height of the scaffold is 4m or more above the last line of ties.

Where ledger bracing is installed for the above reasons, the loads on the adjacent ties will be increased. The system manufacturer's instructions should be consulted to determine whether ledger bracing is required.

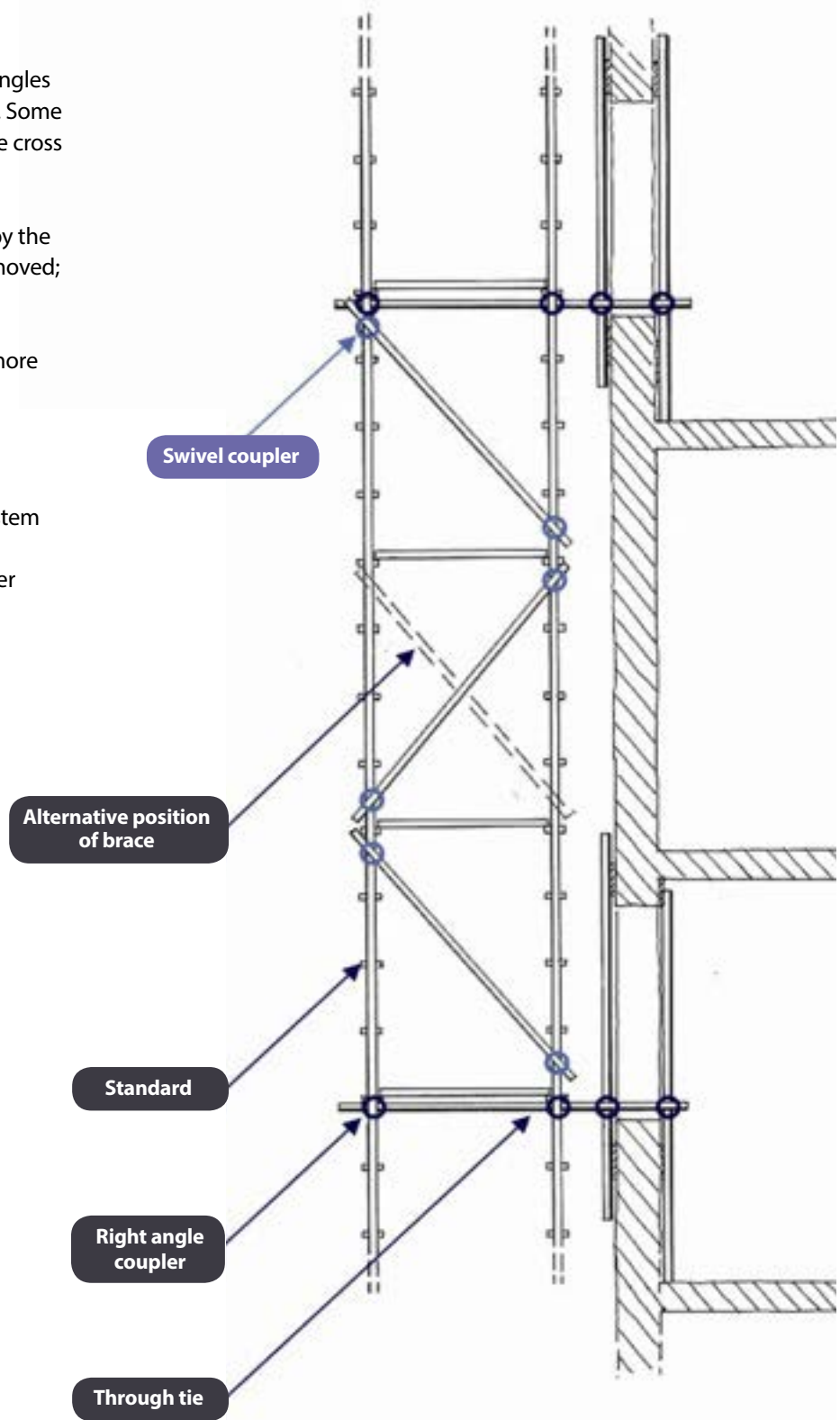

Figure 13: Section Showing Example of Ledger Bracing
(please refer to manufacturer's instructions for ledger bracing requirements)

3. Erection of Scaffolds

Ledger bracing should be installed on tube and fitting scaffolds. Brace alternate pairs of tube and fitting standards, ensuring that the bracing forms a complete series of triangles from bottom to top of the scaffold. Install the bracing from ledger to ledger or from standard to standard. For tube and fitting scaffolds, brace each pair of standards where the bracing is installed from the inside ledger to the guard-rail of the lift below to allow access along a boarded lift.

When clear access is required on base lifts of tube and fitting scaffolds, the cross bracing may be omitted on the base lift provided the first lift does not exceed 2.7m, or the lift is knee braced. In either case, the loading capacity of the scaffold will be reduced.

3.3.4.3 Plan Bracing

Plan bracing should be installed on those horizontal planes of the scaffold that are not stabilised against lateral distortion. The bracing should be connected from standard to standard, forming a complete series of triangles. Examples where plan bracing is required include:

- **Missing ties**

Where an individual tie cannot be installed at the manufacturer's recommended spacing, plan bracing may be used to help span the extended distance between the adjacent ties. Note that the loading on the ties will be increased.

- **Lateral loading**

Where loading bays are connected to the scaffold, the bays should be wing plan braced off the scaffold.

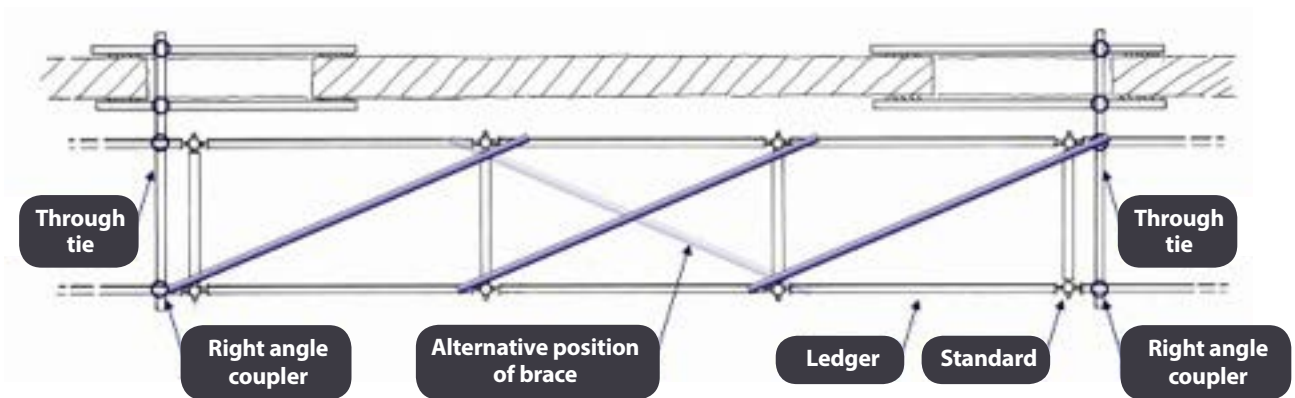

Figure 14: Example of Plan Bracing

(please refer to manufacturer's instructions for plan bracing requirements)

3. Erection of Scaffolds

3.4 Working Platforms

Working platforms should be wide enough and be sufficiently boarded out to allow safe passage of persons along the platform. They should also be capable of resisting the loads imposed upon them, including high wind loads that could dislodge the scaffold boards. The contractor in control of the workplace must risk assess for potential adverse weather conditions.

Where a person could fall a distance liable to cause personal injury, the working platform should be of the widths given in Table A5, Appendix A. A clear passageway, at least 450mm wide, should be maintained for persons to pass between stored materials and the side of the platform. They should be kept free from construction materials and waste to avoid causing an obstruction or a trip hazard.

The [HSA Code of Practice for Safety in Roofwork](#) provides detailed additional guidance on safe practices and systems of work for working on roofs.

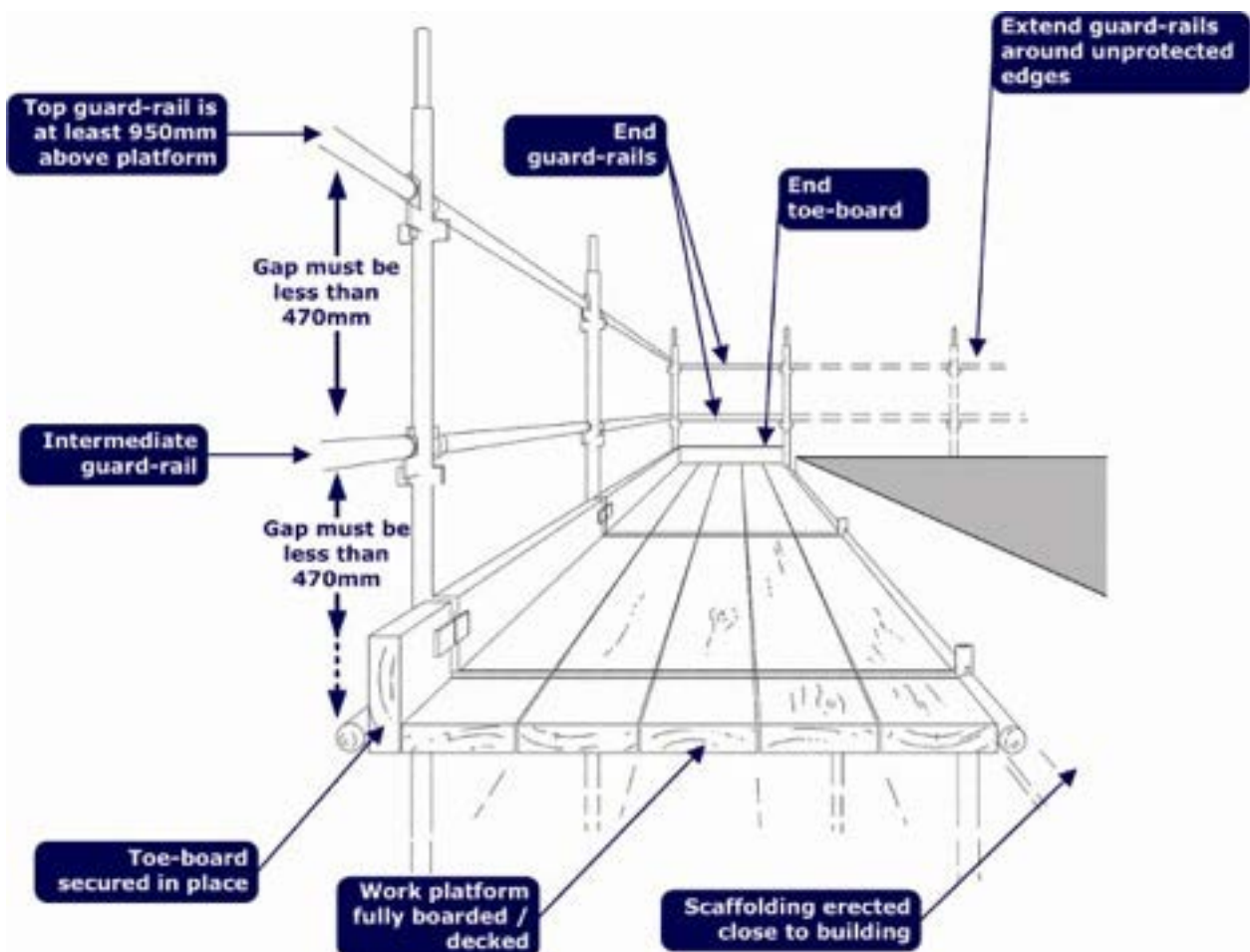

Figure 15: Working Platform

3. Erection of Scaffolds

3.4.1 Decking

Decking may consist of timber boards or proprietary decking units. Where timber boards are used they should comply with I.S. 745, *Machine-graded home-grown timber scaffold boards* or BS 2482:2009, *Specification for timber scaffold boards*. The scaffold boards should not exceed the spans given in Table A2 in Appendix A. These spans may need to be reduced to accommodate heavy loading.

The transoms of many system scaffolds are constructed to provide a secure support for standard-length boards.

Where the transoms do not positively restrain the boards from moving or tipping, the boards should be installed so that they overhang the transoms by at least 50mm but by no more than four times their thickness. Boards that are nominally 38mm thick and less than 2.13m long should not be used unless they are positively restrained to prevent moving or tipping.

NOTE

Particular care must be taken to ensure all boards/decks are secured from dislodgement during high winds. Fatal accidents have occurred when scaffold boards were not adequately secured and were blown off the scaffold by high winds.

Platforms should be maintained in a fully boarded or decked condition. Where a platform has not been fully boarded or has lost boards, either all boards should be removed, or it should be fully boarded as soon as possible. Immediate steps should be taken to prevent access to partially boarded platforms by removing ladders, placing barriers across access points (including windows) and placing "scaffold incomplete" warning signs at all potential entry points.

The use of the scaffold should be monitored to ensure that the manner in which the works are being undertaken is not damaging the working platform, e.g. through the use of abrasive wheels on scaffold boards.

The maximum number of boarded lifts for a system scaffold will be set by the manufacturer and should not be exceeded unless a bespoke design is carried out by a competent person with additional measures taken to support the structure. Designers and erectors should also note that the use of cantilevered board brackets adds additional loading to the inside standard and also that there is also additional loading to the shared standards on ladder and loading bays.

It is essential to have in place a regime of checking boards for defects. Timber boards in particular are susceptible to damage such as mechanical damage, fissures, wane, distortion, insect attack and fungal decay. Damaged boards must be removed from site and put out of use. It is essential that timber boards are stored correctly when not in use to reduce the likelihood of damage.

3.4.2 Toe-Boards

Toe-boards help prevent materials from falling and they also help prevent people falling between the guard-rail and platform. Toe-boards and end toe-boards should be fixed to all working platforms where a person could fall a distance liable to cause personal injury or where an object could fall causing injury. The toe-boards should have a height of at least 150mm above the platform and they should be securely fixed to the standards. Toe-boards must be secured so that they do not become displaced.

3. Erection of Scaffolds

3.4.3 Maximum Gap between Building and Platform

The scaffold should be erected as close to the finished structure as is practicable. The maximum gap between the scaffold and the structure should be 225mm.

Where practicable, the gap should be closed by using cantilever platform brackets at platform level. Internal handrails should be used where the gap between the building and platform is required to be greater than 225mm.

3.4.4 Cantilever Platform (Stage) Brackets

Cantilever platform (stage) brackets may be used to fill the gap between the scaffold and structure and are available in different sizes (consult manufacturer). Some system cantilever brackets require a stabilising tie to be installed. It is essential to fit this tie, as without it the bracket can swivel on the standard and the boards can become dislodged.

Account should be taken of the extra load imposed by cantilever brackets on the inside line of standards. Fitting cantilever platform brackets will generally reduce the working platform service load and reduce the allowable number of boarded lifts and working lifts.

3.5 Guard-Rails

Guard-rails should be provided on all working platforms, including boarded trestles, where a person could fall a distance liable to cause personal injury. Part 4 of the Safety, Health and Welfare at Work (General Application) Regulations 2007 details the requirements for guard-rails. The height of the guard-rail should be at least 950mm above the working platform.

An intermediate guard-rail must be provided such that the maximum distance between the rails and between the lower rail and the toe-board does not exceed 470mm (see Figure 15).

Guard-rails should be capable of resisting reasonably foreseeable horizontal and vertical loadings.

3.6 Falling Object Protection

Measures must be taken to prevent materials from falling from working platforms. A risk assessment will identify the most appropriate precautions for different areas of the site. Exclusion zones may be possible below the works. Areas above pedestrian traffic, particularly those areas above entrances into the structure or above where people are working, will present the highest risk and will require the greatest precautions.

3.6.1 Brick Guards

Brick guards may be hung from the guard-rails and secured to prevent outward movement.

3.6.2 Sheeting

Sheeting may consist of debris netting, plastic sheeting, corrugated sheets or timber sheets. It should be fixed securely to prevent materials from passing through the sheeting. Sheeting should be inspected regularly, particularly after strong winds.

Sheeting will significantly increase the wind loading on a scaffold and on the ties and tie couplers. Consideration must be given to fire risk from sheeting on scaffolds and flame-resistant materials should be used where possible particularly if there will be hot works on the scaffold or if the scaffold is near the public. Note that some flame-retardant sheeting gives off toxic gas emissions when exposed to high temperatures and therefore are not suitable for indoor use.

3. Erection of Scaffolds



WARNING

Scaffolding fitted with debris netting or sheeting will require additional tie support through additional ties or the use of stronger capacity ties, as determined by a competent person. Refer to the manufacturers for information related to fitting of debris netting and tie in requirements.



NOTE

Reveal ties are not suitable for use on sheeted scaffolds.

3.6.3 Fans

Fans normally consist of an inclined support extending from the building and covered in decking. Fans are often the most suitable method of protecting pedestrian traffic areas and access points into the structure. The loads imposed on a scaffold by a fan, i.e. dead load, impact load and wind load, are usually substantial. The top of the fan should be tied to the scaffold where it is tied to the permanent structure and the bottom tube of the fan should be propped against the structure.

Figure 16: Example of a Protection Fan (extract from TG 20)

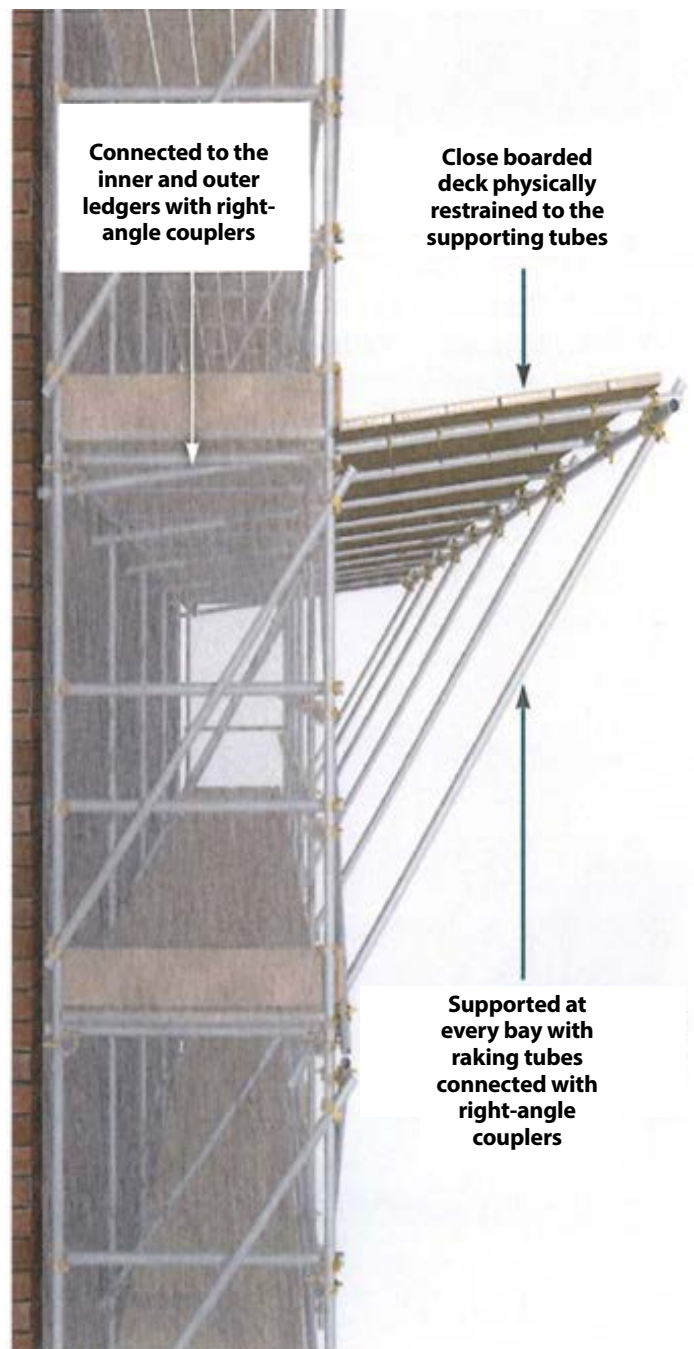

3. Erection of Scaffolds

3.7 Access to the Scaffold

A safe means of access and egress to all working platforms on the scaffold must be provided. This may include gangways, stairways, landings, ladders, ramps or hoists. Priority should be given to providing independent staircase access wherever practicable, particularly when there is high usage of the scaffolding or where materials will need to be carried between lifts by hand.

Sufficient access points must be provided so that workers may easily gain access to their place of work.

An inadequate number of access points may lead to unsafe practices such as workers climbing scaffold components to gain access to or egress from their place of work.

3.7.1 Ladder Access

Scaffold access ladders should meet the following minimum standards:

- ladder access towers, fixed to the outside of the scaffold, should be erected, where practicable using single lift ladders and self-closing ladder gates to separate the access tower from the working platform;
- the top of ladder stiles should be securely fixed to the scaffold by lashings;
- the ladder should be set, where practicable, at an angle of not more than 4 vertical to 1 horizontal and allow sufficient room for workers access and egress through the ladder access opening;
- each stile should be equally supported on a firm and level footing;
- the ladder should extend at least 1m above the landing point unless a suitable alternative handrail has been provided;

- the maximum vertical distance between landings should be 9m;
- where the ladder is internal, guardrails or other protective measures should be in place around the opening to prevent someone stepping into the ladder access opening accidentally;
- the clear dimensions of an access opening in a platform shall be at least 450mm wide, measured across the width of the platform, and 600mm long;

Landings on ladder access towers should be provided with guard-rails and toe-boards and access openings protected with self-closing ladder gates or appropriate trap doors where deemed necessary. The provision of lifts, hoists, staircase towers or ramps should be considered where possible when justified by the frequency of passage, height to be negotiated, duration of use or evacuation requirements (see Figure 17).

3. Erection of Scaffolds

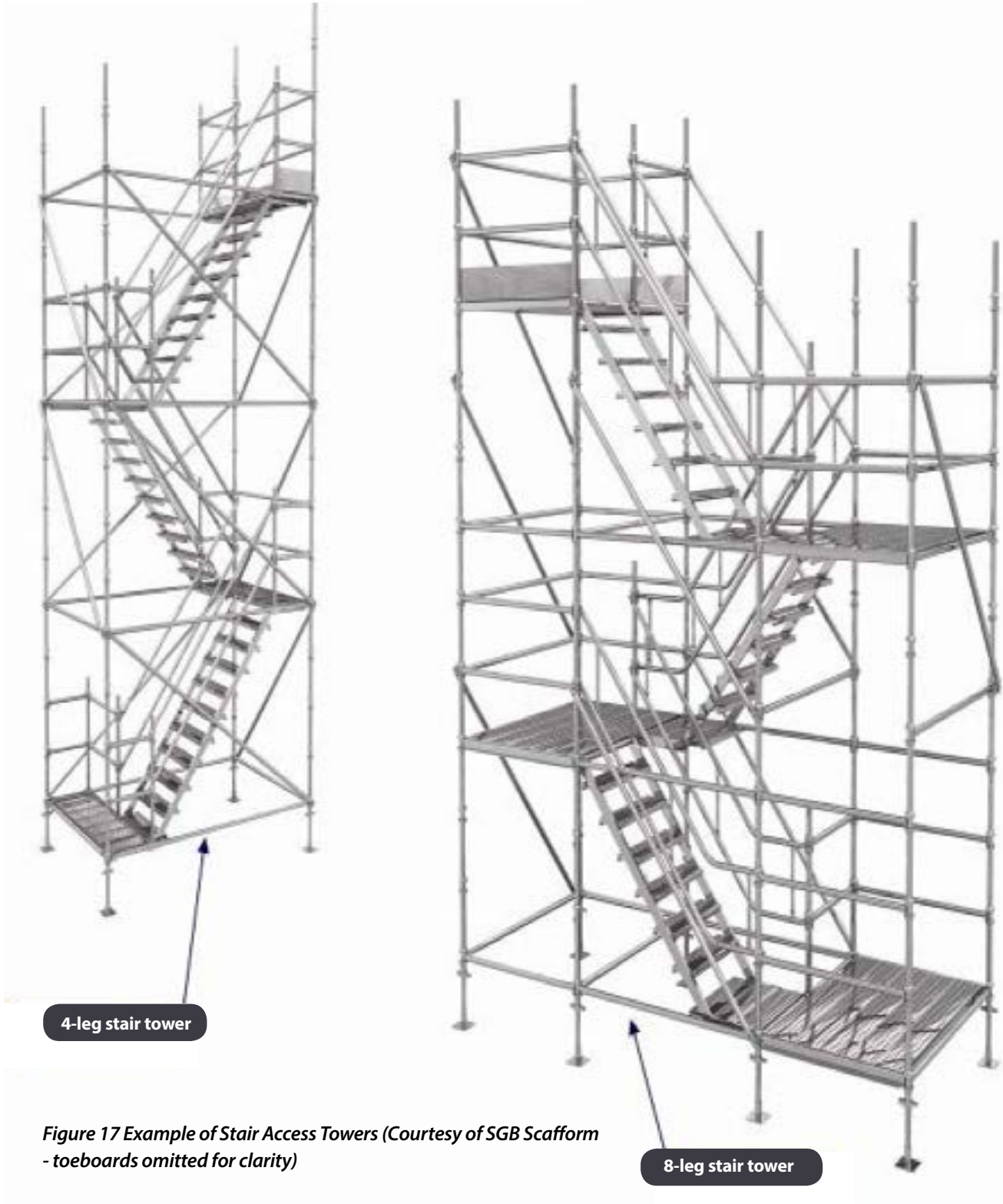

Figure 17 Example of Stair Access Towers (Courtesy of SGB Scafform - toeboards omitted for clarity)

3. Erection of Scaffolds

3.8 Loading of the Scaffold

3.8.1 Loading Bays

The weights of pallets of building materials, such as blocks and bricks, are usually more than the recommended load ratings of the system scaffold manufacturers. A loading bay will therefore be required where it is necessary to lift pallets of heavy materials onto a scaffold. The provision of properly constructed loading bays can avoid the excessive loading of access scaffolds and the obstruction of gangways that can otherwise occur.

The type of loading bay required will vary depending on the chosen method for transporting materials around the site and loading materials onto the scaffolding. A loading bay designed for use by a teleporter is different to a loading bay for use with a crane (see Figures 18 and 19).

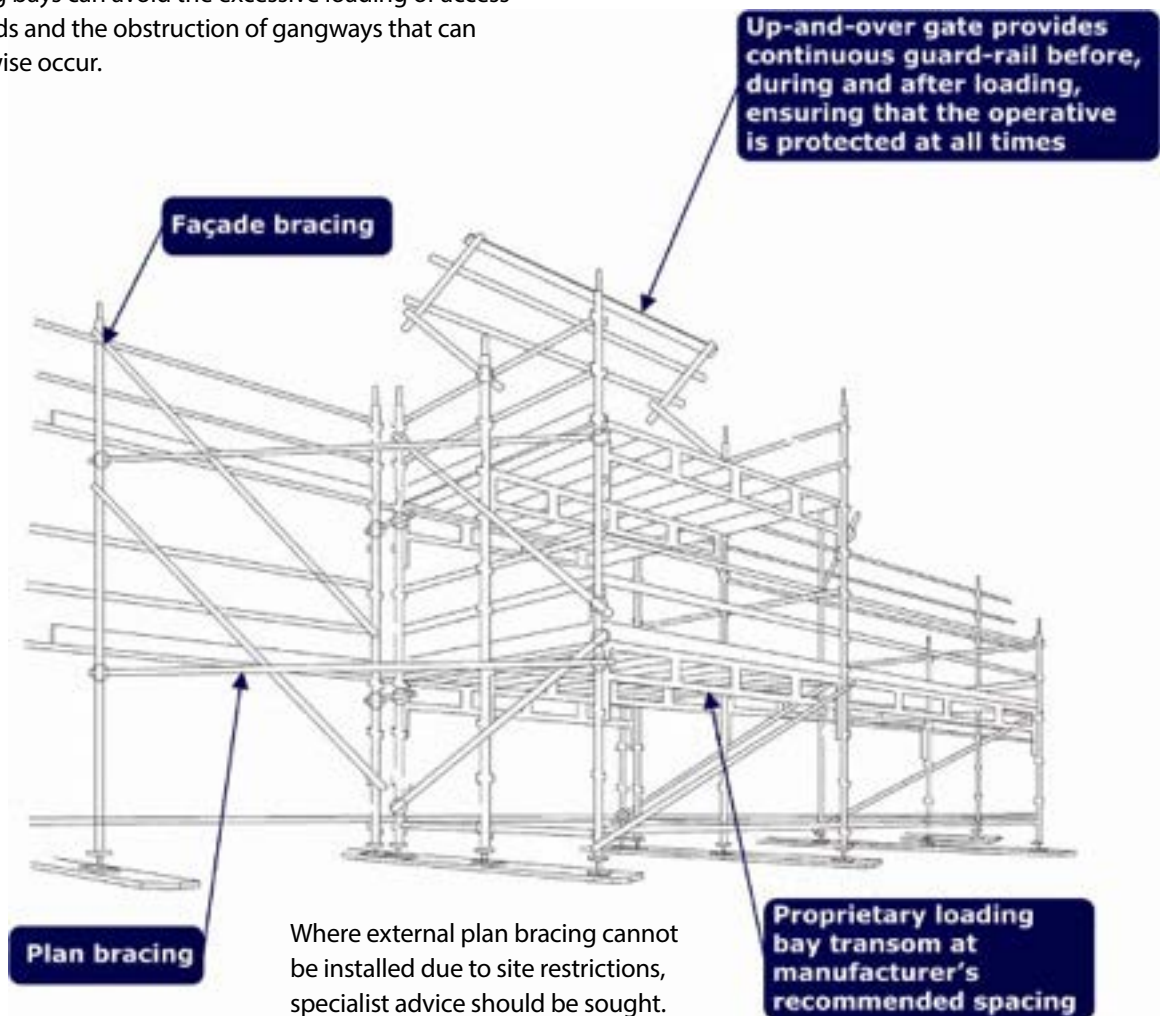

Figure 18: Example of a Loading Bay for Use with a Teleporter

3. Erection of Scaffolds

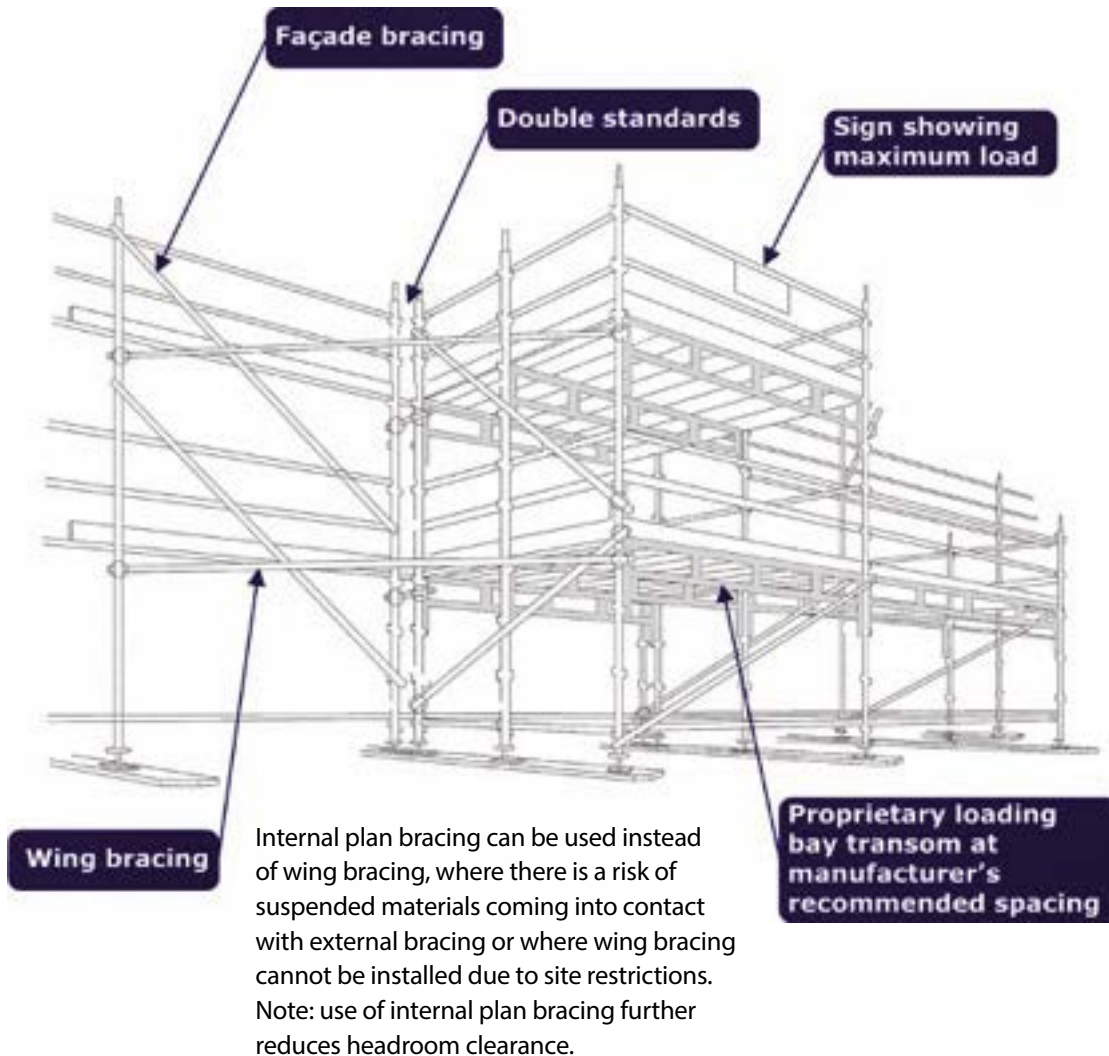

Figure 19: Example of a Loading Bay attached to a façade scaffold for Use with a Crane

Refer to the system manufacturer's instructions for the erection of loading bays. Loading bays should be diagonally braced on all four sides or braced in compliance with the system manufacturer's recommendations. Where the internal façade bracing hinders access onto the scaffold from the loading bay, the brace may be placed on the main scaffold adjacent to the loading bay or in accordance with the system manufacturer's recommendations. Issues that require consideration include:

- Standard transoms at standard spacings and timber/ steel deckings at standard spans are not usually adequate to carry the higher loadings in a loading bay. System scaffold loading bays incorporate special load-bearing transoms, often at reduced spacing.
- Where load-bearing transoms are directly connected to the outside face of a scaffold, the capacity of the standards to support the combined loads imposed by the working platforms and the load-bearing transoms should be assessed.

3. Erection of Scaffolds

- Loading bays are usually restricted to two working lifts, one fully loaded and the other at half that capacity (consult manufacturer's manual or scaffold design for details specific to system being used).
- Plan/wing bracing should be installed from the outside corner of a loading bay to the main access scaffold and the main scaffold should be tied to the building with supplementary ties opposite these braces at intervals not exceeding 3m.
- Where guard-rails must be removed temporarily to facilitate loading, effective compensatory measures to prevent falls should be provided. The use of loading 'up and over' gates and similar systems should be implemented. Other alternative measures may include other movable guard-rails or panels, handholds or safety harnesses affording an equivalent standard of protection as guard-rails. Consideration of loading and unloading must be taken at design stage and a competent scaffolder should construct the scaffolding accordingly.

All modifications to the scaffolding can only be made by a competent scaffolder.

3.8.2 Signs

Easily comprehensible signs showing the safe working load, for each working lift, should be placed on scaffolds and loading bays.

**Maximum Safe Working Load per
2.4m Bay
2kN/m²
(600Kg)**

**(Or 20 concrete blocks and 2
workers)
Evenly distributed**

Figure 20: Example of Sign for Working Platform with Uniformly Distributed Load of 2.0 kN/m²

Warning signs must also be erected on a scaffold that is not available for use, including during its assembly, dismantling or alteration and, where appropriate, the scaffolding should be protected, by barriers or other suitable means, from unauthorised access or use. Scaffold 'tag' systems are available that clearly indicate, usually at ladder access point, if the scaffold is in use or not.

3.8.3 Loading Charts

Supervisors and equipment operators, e.g. slinger/signallers, crane and telescopic handler operators, should be provided with easily comprehensible loading charts showing the weights of the typical materials used on the site, e.g. weights of the pallets of bricks and blocks, scaffold boards and components and mortar skips. This information will enable them to estimate the load they are placing on the scaffold and ensure that it is less than the safe working load indicated on the signs.

3.9 Free-Standing and Mobile Access Towers

Free-standing and mobile access towers can provide a safe means of working at a height provided that they are properly constructed and used. Access towers have, however, been associated with serious accidents due to overturning or contact with overhead electricity lines.

3.9.1 Types of Tower

The main types of tower in use are aluminium alloy towers, GRP (Glass Reinforced Plastic) towers and steel towers. Components may include prefabricated frames, platforms, bracing, castor wheels and outriggers. Steel towers are constructed from system scaffold components or from tube and fitting components.

3. Erection of Scaffolds

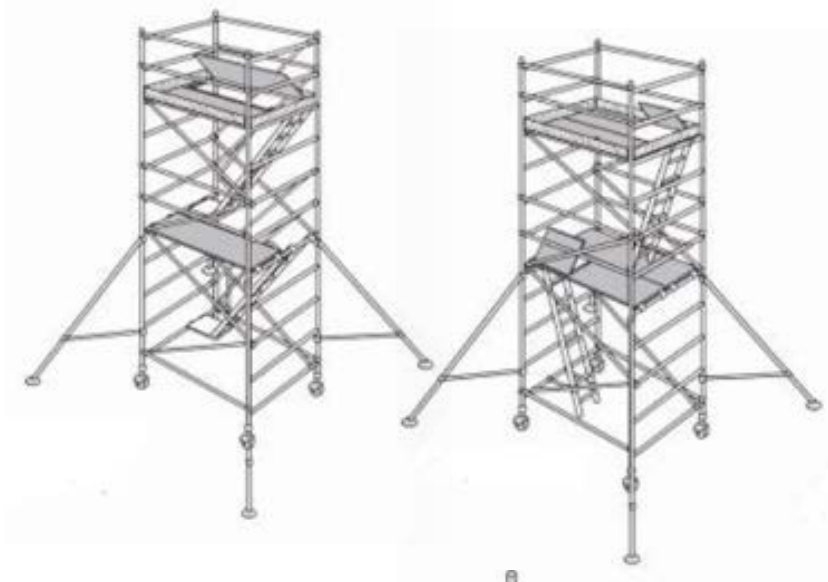

Figure 21: Example of Mobile Towers with Ladder Access and with Stairway/Stair-ladder Access (From PASMA)

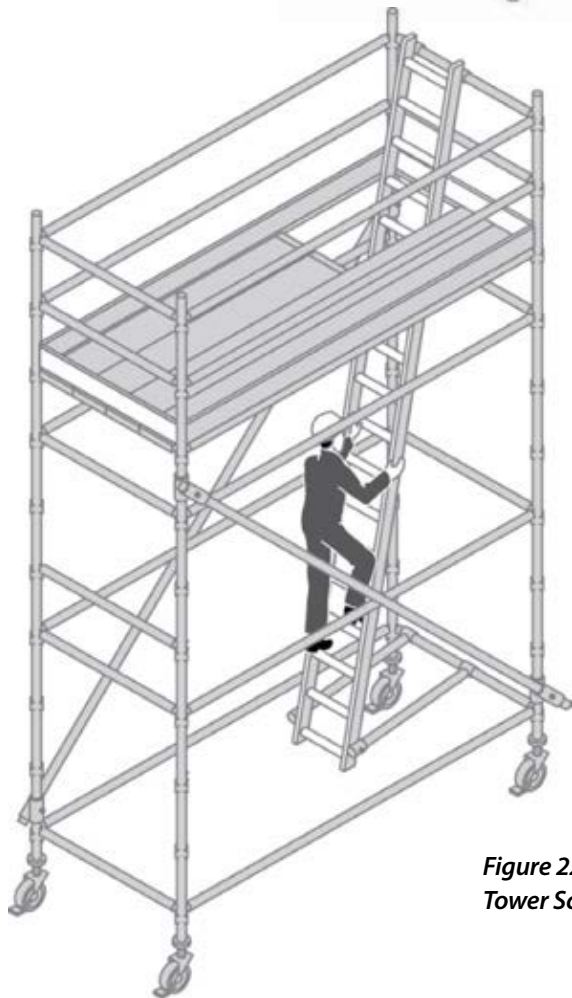

Figure 22: Example of Mobile Tower Scaffold

3. Erection of Scaffolds

I.S. EN 1004, 2005: Mobile access and working towers made of prefabricated elements – Materials, dimensions, design loads, safety and performance requirements gives minimum specifications for standard mobile prefabricated towers with platform heights from 2.5m to 8.0m when used externally and 2.5m to 12.0m when used internally.

3.9.2 Manufacturer's Instructions

The manufacturers and suppliers of prefabricated tower scaffolds must provide instructions (which comply with I.S. EN 1298, 1996: Mobile access and working

towers – Rules and guidelines for the preparation of an instruction manual). These instructions must be available to people assembling and using these scaffolds and they must be followed.

3.9.3 Falls from a Height – During Assembly and Dismantling

There are currently two methods of providing a safer environment during the assembly, altering and dismantling of mobile access towers. These methods take account of the need to prevent falls during these processes.

- **Advanced Guard-Rails**

This method uses an additional set of equipment allowing guard-rails to be placed ahead of the platform from the safety of the level below so that collective fall prevention measures are in place before the operative stands on the platform (see Figure 23 – toe-boards omitted for clarity).



Figure 23: Advanced Guard-Rail Method for Erection of Mobile Towers (From PASMA)

- **3T – Through the Trapdoor**

This method allows the operatives to position themselves through the trapdoor of the platform and place horizontal braces ahead of themselves so that collective fall prevention measures are in place before they stand on the platform (see Figure 24 – toe-boards omitted for clarity)



Figure 24: Through the Trapdoor Method for Erection of Mobile Towers (From PASMA)

3. Erection of Scaffolds

SAFE ERECTION AND DISMANTLING OF TOWER SCAFFOLDS

One method of erection is the 'through-the-trapdoor' (3T). This allows the person erecting the tower to take up a position of minimum risk during the installation of guard-rails to the next level. It involves the operator taking up a working position in the trapdoor of the platform, from where they can add or remove components which act as the guard-rails on the level above the platform. It is designed to ensure that the operator does not stand on an unguarded platform, but installs the components to a particular level while positioned within the trapdoor of that same level.

The T3 method makes use of standard tower components.

3.9.4 Falls from a Height – Personal Fall Protection Equipment

It is recommended that you do **not** attach safety harness lanyards to mobile access towers. In the event of an arrested fall, you are likely to cause the tower to overturn, not only increasing the risk of further injury to yourself, but also endangering others in the vicinity from the falling tower.

3.9.5 Stability

The conditions of use of the tower and environmental forces such as wind can adversely affect tower stability. Where the conditions of use or the wind forces are likely to be different from those covered by the manufacturer's instructions, or where the tower is erected in a location exposed to high winds, the overturning forces should be calculated by a competent person. Appropriate measures should be taken to ensure that the tower has a factor of safety against overturning of at least 1.5 in any direction (see Section 2.3.2).

NOTE

The stability of free-standing towers that are likely to be exposed to high winds, other significant horizontal loads or where loads will be hoisted outside the middle third of the base width should be evaluated. Where there is a danger of overturning, an adequate safety factor against overturning in any direction should be obtained by the provision of stabilisers, outriggers, kentledge, guys or ties to adjoining structures as per the designer's advice.

3.9.6 Ground Surface

The ground surface should be suitable for the type of tower to be used. Where castors are to be used, the surface should be even, and holes, ducts, pits or gratings should be securely fenced or covered. Where the surface is sloping, the tower should be prevented from slipping. Base plates and sole boards should be used where the ground is soft.

3. Erection of Scaffolds

3.9.7 Bracing

Prefabricated towers should be braced in accordance with the manufacturer's instructions. Where the tower is constructed of tube and fitting components, it should be adequately braced on all four sides and be braced in plan at every alternate lift.

3.9.8 Castors

Castors should be fitted with adequate brakes and they should be securely fixed to each leg of the tower to prevent accidental uncoupling. In a case where the castors or legs are adjustable this is only generally for levelling purposes and should not be used as a means of increasing the working platform height.

3.9.9 Working Platform

The deck units or boards should be securely fixed to the frame. Toe-boards and guard-rails should be provided. The platform should not be overloaded.

3.9.10 Tower Access

Access should be provided to the tower using vertical or integral ladders, inclined internal ladders or stairways erected in accordance with the manufacturer's directions. Ladders should be attached to the shorter side of rectangular towers and within the base area of the tower. External ladders should not be used with aluminium towers. Access to the platforms should be through a hatch that is capable of being closed and secured.

3.9.11 Overhead Electricity Lines

Mobile access towers should not be used in locations adjacent to overhead electricity lines. Where mobile access towers are being used in the same general area as overhead electricity lines, physical barriers and warning notices should be provided to prevent people coming close to them.

3.9.12 Instruction, Training and Supervision

Prefabricated towers such as aluminium alloy towers may only be erected by competent workers with sufficient skills and training. Workers should be provided with adequate and comprehensible instructions both for the erection and checking of the tower.

People who erect mobile towers must have successfully attained the QQI (or recognised equivalent) award and be in possession of a SOLAS Construction Skills Certification Scheme (CSCS) card for mobile tower scaffolds. A scaffolder with a SOLAS basic or advanced scaffolding CSCS is not required to also have the CSCS for mobile tower scaffolding.

Competent supervision should be provided to ensure that towers are safely erected, checked and used.

3.9.13 Tower Use

Vertical or horizontal forces capable of overturning a tower should not be applied. Such forces may arise from pulling or pushing the tower along at a high level, lifting loads up the outside of the tower or hauling heavy ropes or cables. Using hand tools such as drills can cause an additional horizontal force on the tower.

The tower should not be moved with workers or materials anywhere on the tower. It should be moved manually, pushing the tower at or near the base. Mechanical means should not be used to push towers.

The tower or its platforms should not be overloaded. The castors should always be locked, except when moving the tower. Chocks should be used where there is any doubt about the adequacy of the brakes. Standard-width scaffold couplers should not be used on aluminium alloy towers. The access tower should be inspected and form GA3 (see Appendix C), or some other suitable method of recording the required information, should be completed before using the tower.

Warning notices should be placed on incomplete towers.

3. Erection of Scaffolds

3.9.13.1 Prefabricated Aluminium or Glass Reinforced Plastic (GRP) Towers

Aluminium and GRP towers are light. This lightness is a positive advantage in relation to ease of erection and use and may help to avoid manual handling injuries. A light aluminium or GRP tower will, however, be less stable than a heavier steel tower of the same dimensions.

Prefabricated towers designed and constructed in compliance with I.S. EN 1004, 2005 should be stable in winds below 45km/h (12.5m/s). Where winds approaching this speed are expected, precautions should be taken such as tying the tower to adjoining structures or dismantling the tower to prevent it being blown over. Work on prefabricated towers should cease when wind speeds exceed 27.5km/h (7.7m/s) unless the manufacturer's or supplier's instructions explicitly permit such work. Towers should be inspected after high wind events and the results of the inspection should be recorded.

The manufacturer's instructions should be followed, and the tower should not be assembled to a height above that recommended by the manufacturer for the specified stabilisers or outriggers, which must be installed correctly and at the appropriate point in the assembly sequence.

3.9.13.2 Steel Towers

The height to least base dimension ratio for unsheathed mobile towers should not be greater than three. When used in exposed situations, the tower should be tied to the building it is serving. The maximum height in this Code is 8m; mobile towers higher than this should have a bespoke design by a competent scaffolding designer. Note that other lower level towers may also require a specific design if used in configurations outside the manufacturer's manual.

Towers outside are usually exposed and are therefore subject to wind forces. Frequently towers with a height to least base dimension ratio greater than three are unstable in locations exposed to high winds. For these circumstances, the wind forces should be calculated and the tower restrained by kentledge or guys, to give a factor of safety against overturning of 1.5 in any direction.

In calculating the height to base ratio, measure the height from ground level to the working deck or top lift and measure the base width as the least base dimension, centre to centre, of the shortest side of a rectangular tower.

3. Erection of Scaffolds

3.10 Electrical Dangers

3.10.1 Overhead Electricity Lines

Overhead electricity lines can present a serious safety risk, particularly in areas where construction activities are being carried out. Appropriate measures must be taken to identify and control the risk.

The erection and removal of scaffolding near overhead electricity lines can present particular risks as scaffolding materials are normally good conductors of electricity, are handled manually and may have the potential to touch or come within arcing distance of the live overhead line conductors. Furthermore, once scaffolding has been erected, work activities being carried out on the scaffolding can present similar safety risks, especially while materials are being handled or long handle tools are being used. Risks can also arise in windy conditions from live conductors blowing towards or touching the scaffold and thereby making the entire scaffold assembly live.

Working near overhead electricity lines is a listed particular risk under the Safety, Health and Welfare at Work (Construction) Regulations 2013 and should therefore have been identified by the PSDP and the designer at the design stage of the project. The ESB Approved Code of Practice for Avoiding Danger from Overhead Electricity Lines details the requirements when such work is undertaken including where it is necessary to contact ESB Networks/service provider.



WARNING

All scaffolding must be erected outside the "Hazard Zone". Refer to the ESB Approved Code of Practice for Avoiding Danger from Overhead Electricity Lines for further details.

Appropriate control measures should be based on a site-specific risk assessment and detailed in the safety statement and/or the safety and health plan. These measures will normally include one or more of the following, in order of preference: rerouting the lines; having the lines switched out and earthed; and installing barriers or insulation between the scaffold and the lines. These measures must be agreed in consultation with ESB Networks/electrical service provider.

In addition, scaffolds erected adjacent to overhead lines should be earthed.

The ESB Networks *Code of Practice for Avoiding Danger from Overhead Electricity Lines (HSA Approved COP)* gives practical guidance on how to carry out work safely in the vicinity of overhead lines. Any person who has a responsibility for design, erection, dismantling or use of scaffolding near overhead electricity lines should refer this approved ESB COP. It gives the appropriate "Hazard Zone" and "Exclusion Zone" dimensions that apply for the different voltage levels of overhead lines.

In the case of LV overhead lines (i.e. where the voltage is less than 1,000 volts), it may be feasible for ESB Networks to replace bare, open wire conductors with insulated, aerial bundled conductors or to temporarily insulate the conductors by applying approved temporary shrouding and other protection to the conductors to facilitate scaffolding and certain work activities within the "Hazard Zone" of such lines. Where LV overhead line conductors have been temporarily shrouded or appear to be insulated, this does not mean that they are safe to touch. The effectiveness of the shrouding or insulation will depend on conditions such as the prevailing weather and the time involved.

Where insulation has been provided by ESB Networks as a means of temporarily reducing the risk of inadvertent contact by a third party working near a live LV overhead line, the third party should ensure that if

3. Erection of Scaffolds

the protection is damaged or dislodged that all work within 3m of the damaged area is stopped and that ESB Networks is notified immediately. All control measures specified by ESB Networks should be implemented and all relevant employees and sub-contractors should be aware of the safety requirements.

In the event of an accident or an emergency with an overhead electricity line or underground cable, contact ESB Networks' 24-hour emergency telephone number.

3.10.2 Portable Electrical Equipment

Portable tools rated less than 2kV amperes and used in construction should operate at no more than 125V AC and be centre tapped to earth.

3.10.3 Lightning

Scaffolds on the roofs of high buildings or associated with some topographical features are susceptible to being struck by lightning. Such scaffolds should be earthed. (Reference NASC SG3:14 Earthing of Scaffolding Structures)

3.11 Erection on Public Streets/ Places

The erection and use of scaffolding adjacent to public streets/ places creates hazards for the public that are like those encountered by site workers. The precautions will, however, need to be greater because of the large numbers of persons who may be at risk, their unfamiliarity with the dangers and their curiosity about the work. High standards of physical protection and effective systems of work and supervision should be provided to protect the public.

Particular requirements are outlined in Regulations 30 and 97 of the Safety, Health and Welfare at Work (Construction) Regulations 2013 which addresses arrangements to protect the public from injury caused by the works and by passing traffic respectively. The public should be excluded from the area around the work during scaffold erection, modification and dismantling.

This requirement may involve getting permission to close streets or footpaths while the scaffold is being erected or dismantled.

Where the public cannot be excluded, effective physical protection should be provided to prevent persons being struck by falling tools or materials. Platforms can be double-boarded with sheets of plastic or other material between them to prevent construction material and dusts from falling on anybody passing underneath. Where necessary protective fans should also be put in place. Consideration must be given to providing a safe covered walkway area for the public to pass by the scaffold in a safe manner.

Where footpaths are closed, adequate provision should be made to protect pedestrians from traffic. Public access to the scaffold should, so far as is practicable, be prevented by providing hoardings and/or sheeting and by removing or preventing the use of access ladders at a lower level. Local Authorities will require a contractor to apply for a hoarding licence and a scaffolding licence.

3.11.1 Through Access

Where members of the public are permitted to walk through the base of the scaffold, precautions should include:

- as the bottom ledgers and transoms will be omitted, the scaffold will require a specific design;
- the provision of sufficient headroom;
- ensuring there are no projections that may injure people or damage their clothing;
- provision to prevent any materials, dusts falling through the scaffolding;
- provision and maintenance of a sound walking surface; and
- provision and maintenance of adequate lighting.

3. Erection of Scaffolds

3.11.2 Adjacent Parking or Traffic

The scaffold should be protected from traffic by appropriate warning signs, lights, barriers or traffic cones. Where vehicles are permitted to park adjacent to the scaffold, the risk of damage to the scaffold is high, particularly so if the vehicles park nose-in or tail-in to the scaffold. Vehicle damage should be avoided by preventing such parking or by providing barriers. Where this is not practicable, the scaffold should be inspected frequently so that damage may be detected

and remedied quickly. Reference the Department of Transport Chapter 8 Guidance on Temporary Traffic Measures and Signs for Roadworks and associated guidance when encroaching on roads, paths etc.

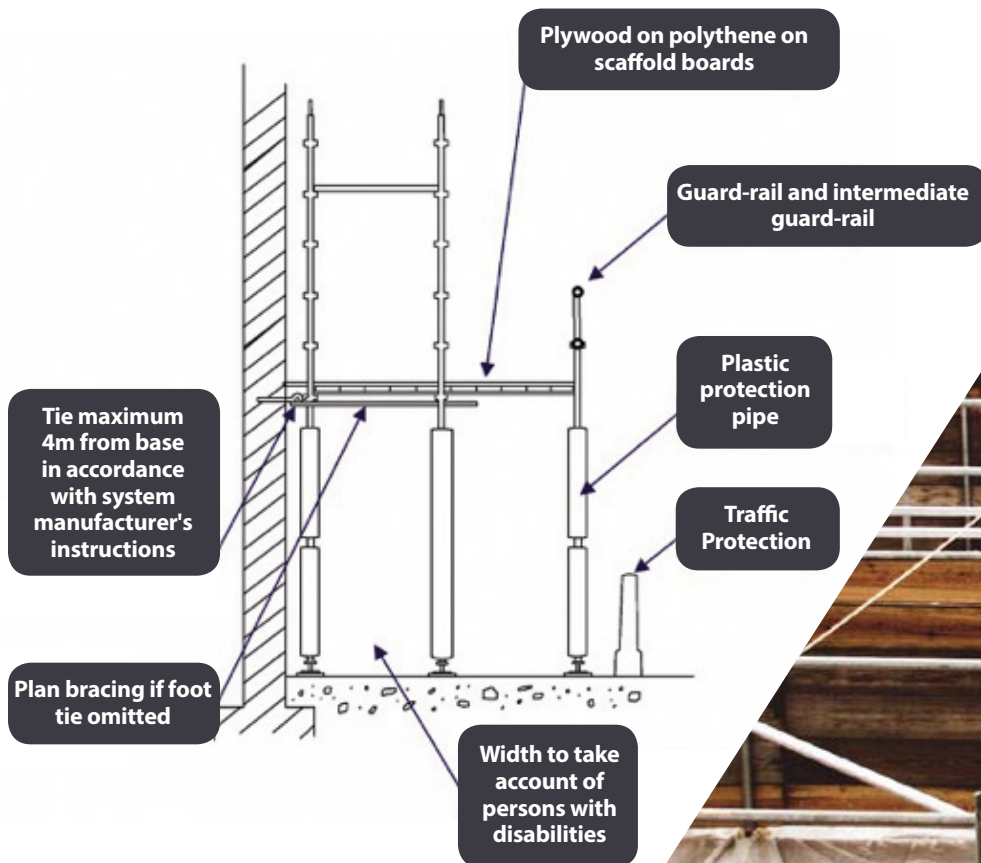

Figure 25: Example of Pedestrian Through Access
(note sway bracing must remain in place)



4. Inspection and Handover

An adequate handover procedure for transferring control of the scaffold from the erector to the user is an important part of managing scaffold safety. Both the scaffold erector and the user should be satisfied that the scaffold can provide a safe working platform and can carry the imposed loads safely. An adequate handover procedure will include:

- clearly identifying the areas of the scaffold that have been handed over;
- clearly stating the maximum capacity of the loading bays and working platforms and the tie spacing;
- inspecting the entire area of the scaffold before it is taken into use. The scaffold inspection checklist given in Appendix B (Checklist 2: *Inspection of Scaffolding in Use*) or another suitable checklist may be used;
- scaffolding components must be inspected frequently, by a competent person, to ensure that they are in safe working order.

The frequency will be determined by the manufacturer's instructions and taking account of the conditions under which the components are being used. Non-galvanised painted steel scaffolding is particularly prone to rust and corrosion damage which can greatly weaken the components. Any defective components must be removed from site and put out of use. Components may be able to be repaired but this can only be carried out by a competent person. Sandblasting and painting only of components, while preventing further deterioration of the component, does not repair them and can lead to masking of defects;

- scaffold boards must be inspected as part of any inspection routine. Timber boards can suffer from fissures, wane, mechanical damage, distortion, insect attack and fungal decay. Any defective boards should be replaced and removed from site;
- removing "scaffold incomplete" warning notices from the finished scaffold and erecting "scaffold complete" signs (using a scaffolding tag system or other similar system can be very beneficial in identifying which scaffold sections are safe to use and which are not);
- preparing a report of the inspection, e.g. using form GA3 "Report of results of inspections of Work Equipment for Work at a Height" (see Appendix C) or similar. A copy of the report should be retained on site; and
 - identifying the person responsible for further modifications and inspections of the scaffold.

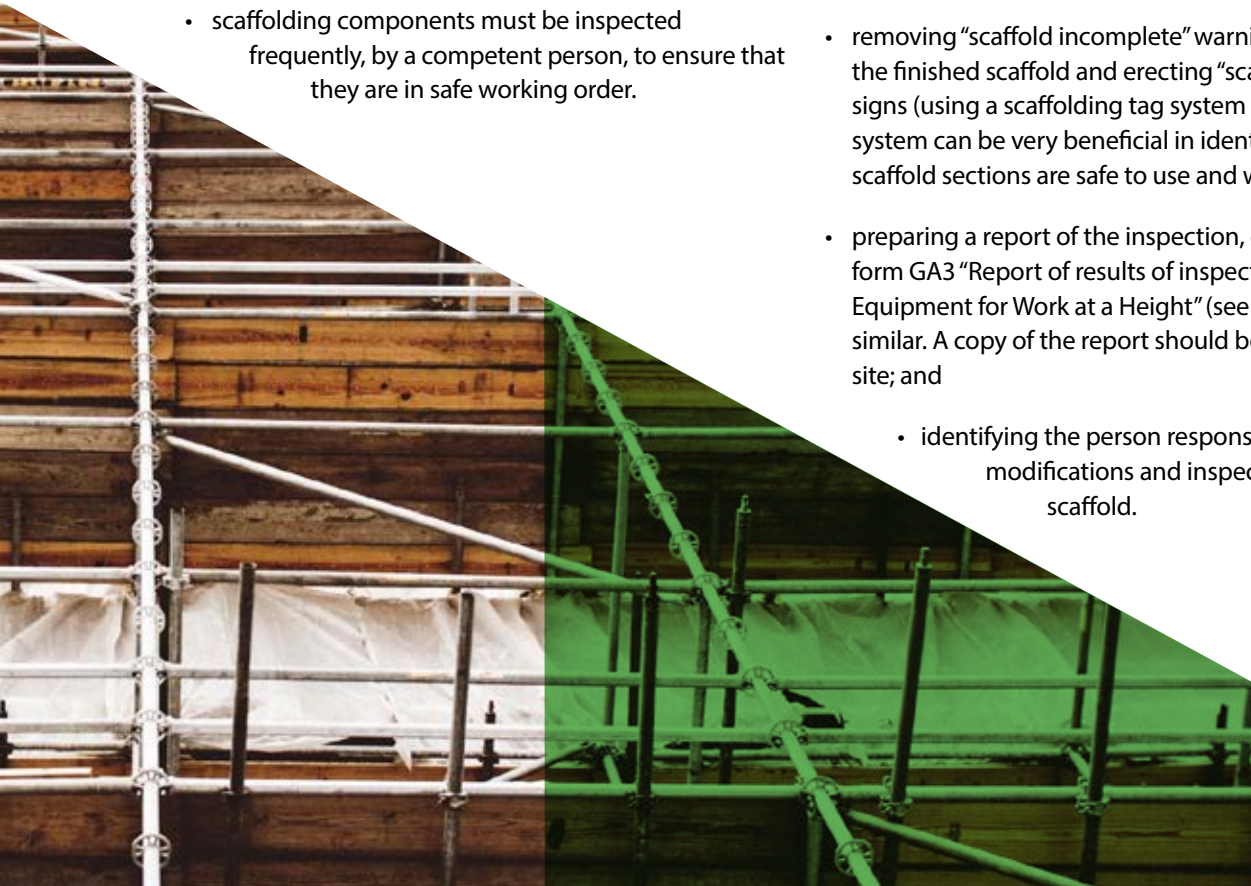

5. Use, Modification and Maintenance

5.1 Scaffold Users

A scaffold should not be used unless it is properly constructed and is suitable for the purpose for which it is required, has been inspected and form GA3 "Report of results of inspections of Work Equipment for Work at a Height" (see Appendix C) has been completed.

Where the scaffolding platform exceeds 2m in height, each contractor (including sub- contractors and the self-employed) should be satisfied that the scaffold has been inspected by a competent person within the previous seven days and should therefore ask to see the report of the inspection, which can be form GA3 or any alternative form that contains the required information.

The PSCS/contractor responsible must provide and communicate the relevant information on the conditions of use of the scaffold, including the loading capacity of the scaffold, in a comprehensible form to the users. Scaffold tag systems can be effective in this regard.

Users (including contractors and workers) who discover a serious defect in a scaffold, which may adversely affect their or another's safety, should stop using that scaffold and report the defect to the site management.

Users should:

- be provided, by the PSCS/contractor responsible, with relevant information on the conditions of use of the scaffold, including the loading capacity of the scaffold, in a comprehensible form;
- not overload the scaffold either locally or in general;
- not interfere with or misuse the scaffold;
- promptly report defects in the scaffold to whoever is in control of the scaffold; and
- not leave a scaffold in a hazardous condition for current or subsequent users.

5.2 Modification

Uncontrolled modification of a scaffold, particularly if carried out by people without adequate competence, can lead to instability and an increased risk of people falling from the scaffold. Modifications to ties, bracing, ledgers, transoms and decking should be identified, requested and made in good time (see Section 2.5). Only competent scaffolders who have been trained and are experienced in this kind of work may make modifications to scaffolds.

A sufficient number of competent scaffolders should be available to ensure that modifications are made in good time.

Guard-rails and toe-boards may only be removed by competent scaffolders.

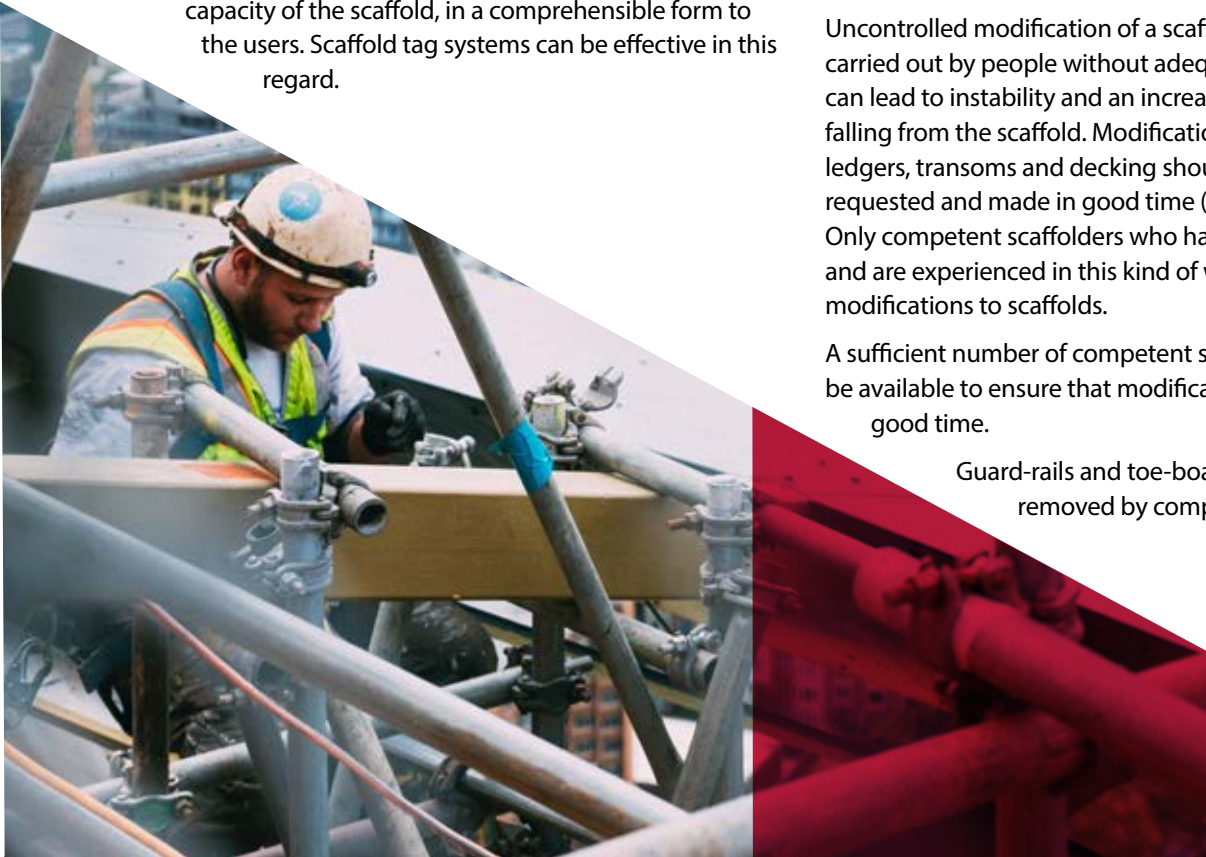

5. Use, Modification and Maintenance

5.3 Maintenance

The scaffold should be maintained in a safe condition for the entire period of its use (see Section 2.6).

5.4 Inspection Before and During Use

Scaffolds should be inspected by a nominated competent person before use and again at least every seven days and after any circumstance that might affect the stability or safety of the scaffold. Such circumstances include:

- modification;
- period without use;
- exposure to bad weather;
- damage, including impact of traffic or site equipment with the scaffold; and
- after excavating in close proximity to the base of a scaffold.

The scaffold inspection checklist given in Appendix B or another suitable checklist may be used. A report of the inspection should be made on a suitable form, such as form GA3 (see Appendix C for scaffolding GA3 template), and a copy of the report should be retained on site.



6. Dismantling

Dismantling a scaffold can place large loads on the scaffold unless the work is planned to keep the amount of material stored on the scaffold to a minimum. The work should be planned so that the scaffold remains stable, workers are prevented from falling from the scaffold and others are protected from the risk of falling materials.

6.1 Stability

The scaffold should be examined to ensure that the foundation is adequate and that all ties and braces are in position and are effective.

Any defects found in the scaffold should be made good before commencing dismantling.

The dismantling should be planned and risk assessed so that stability is assured by providing adequate bracing and ties and by restricting the imposed loads due to stacked scaffold components.

Where the scaffold must be used to temporarily store large amounts of components, it should be strengthened and stabilised, e.g. by providing extra standards, ties or rakers.

Prominent warning notices should be placed and access to the danger zone should be prevented.

The contractor responsible for the construction site must ensure the scaffolding is cleaned down prior to dismantling. Building material, waste materials and dusts must be removed. Construction dusts, including silica dusts, are common on scaffolding decks and can lead to serious respiratory illnesses if not controlled in an appropriate manner.

6.2 Protection from Falls

Workers should be protected from falling during dismantling of scaffolding (see Section 3.1).

6.3 Protection from Falling Objects

Workers and members of the public should be protected from the risk of being struck by falling scaffold components (see Section 3.6).

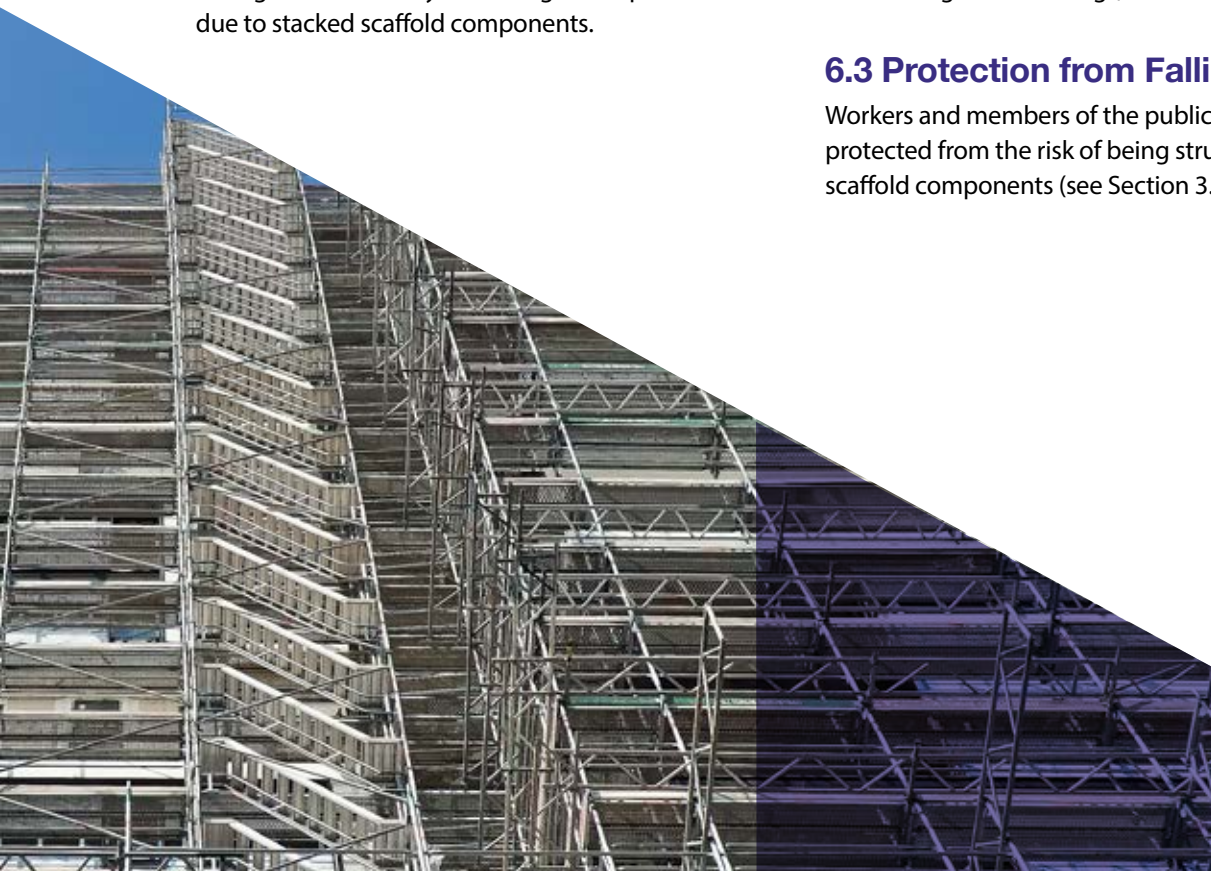

7. Competence

The risks associated with the erection, use and dismantling of scaffolding are potentially very high. People given the task of erecting, altering, using or dismantling scaffolding should have the necessary competence to perform their tasks safely, as outlined in Figure 27.

7.1 Competence of Scaffolders

A scaffold should not be erected, substantially added to, altered or dismantled unless the work is performed by basic or advanced scaffolders trained and experienced in that kind of work or trainee scaffolders under the direct supervision of a competent person (either a basic or an advanced scaffolder, depending on the nature and complexity of the scaffold).

In the case of scaffolding, direct supervision is intended to ensure that the trainee's safety is protected at all times and that the skills necessary to safely complete the job are comprehensively communicated and demonstrated. To achieve this, the supervising scaffolder must ensure that the trainee scaffolder can be organised, directed, observed, communicated with and monitored at all times.

In considering the nature, scale and complexity of the scaffolding activities, the scaffolding contractor must always ensure that the trainee scaffolder is undertaking work that is within his or her training, knowledge, experience and capabilities.

Under no circumstances should a trainee scaffolder be performing duties without supervision.

A competent person is a person who has been fully trained, has acquired the necessary knowledge and practical experience and has received the necessary instructions for the erection, alteration or dismantling of the type of scaffold. The CSCS assessment is only part of ensuring competence. Experience and knowledge specific to the scaffolding type is also necessary. Familiarisation training may be necessary for scaffolders who start using a new or unfamiliar scaffolding proprietary system.



7. Competence

SCAFFOLDING SCHEMES

Trainee Scaffolder:

The trainee scaffolder is permitted to participate in general scaffolding operations, provided that the trainee scaffolder is at all times under appropriate supervision of a competent person such as a person competent at the level of scaffolding for which the trainee is under training for.

CSCS BASIC SCAFFOLDING SCHEME

Participants must:

- Be of statutory school leaving age (16 years);
- Have a minimum of 9 months full time experience, assisting in the erection and dismantling of a range of scaffolding;
- Have a valid Safe Pass Registration Card;
- Complete a CSCS Assessment scheme for Basic Scaffolding

Basic Scaffolder:

A basic scaffolder can undertake:

- general scaffolding operations other than those requiring an advanced scaffolder;
- Proprietary / system scaffolds only;
- Loading bays not exceeding 7m in height
- When the basic scaffolder is undertaking advanced scaffolding operations (for the purposes of training), the scaffolder must be under the appropriate supervision of a competent person such as an advanced scaffolder.

CSCS ADVANCED SCAFFOLDING SCHEME

Participants must:

- Have a valid basic scaffolder CSCS card for 12 months;
- Have a minimum of 12 months experience as a trainee advanced scaffolder
- Have a valid Safe Pass Registration Card
- Complete a CSCS Assessment scheme for advanced scaffolding

Advanced Scaffolder:

Proprietary / system scaffolds and tube & fitting scaffolds;

- Bespoke designed scaffolds; - Sheeted system scaffolds;
- System scaffolds where the maximum height, tie spacing, imposed loads, bay widths or number of working lifts exceeds the manufacturer's recommendations;
- Tube and fitting scaffolds where the height exceeds 50 metres for un-sheeted scaffolds and 25 metres for sheeted scaffolds;
- Scaffolds with temporary roofs;
- Scaffolds subjected to impact e.g. mechanical loading of heavy materials onto working platforms;
- Scaffolds where the bottom transoms or ledgers have been omitted to allow pedestrian access;
- Scaffolds where the first line of ties is more than 4 metres above the base of the scaffold;
- Scaffold buttresses;
- Special scaffolding including loading bays greater than 7m, protection fans, nets, pavement frames, cantilever scaffolds, truss-out scaffolds, free standing external towers, hoist towers, slung scaffolds, pedestrian bridges and walkways, temporary ramps and elevated roadways, masts, lifting gantries, temporary buildings and roofs;
- Scaffolds where the required bracing is omitted;
- Scaffolds where the allowable bearing pressure on the ground may not be adequate to support the scaffold

Figure 27: Achieving Competency

7. Competence

7.1.1 Training

Formal training is required for those who erect, add to, alter or dismantle a scaffold. The training should include instruction on any risks involved. The extent of training required will depend on the type of work normally undertaken and on the type of scaffold. The minimum acceptable standard of training is the approved Construction Skills Certification Scheme (CSCS) for Basic Scaffolders, or an equivalent training programme accredited by SOLAS. Scaffolding activities beyond the range of general access scaffolds require the erector to be trained to an advanced level.

NOTE

Scaffolders must be trained as Basic Scaffolders or Advanced Scaffolders, taking into account the type, nature and scale of the scaffolding that they are erecting.

7.1.2 Experience

A competent and experienced person should supervise the erection, alteration or dismantling of a scaffold. The person should be experienced in the kind of work being undertaken.

7.1.2 Assessment, Certification and Registration

To help employers, contractors and project supervisors determine whether scaffolders have the necessary competence to erect or dismantle scaffolding, SOLAS through the Construction Skills Certification Scheme assess scaffolders, apply for certificates, issue cards and keep a register of certified scaffolders.

On successful completion of the initial training and CSCS assessment, scaffolders should keep a record of their subsequent work experience.

Employers, contractors and project supervisors for the construction stage should satisfy themselves that people erecting scaffolding have the necessary training by seeking evidence of QQI certification or an equivalent qualification accredited by SOLAS.

7.1.3 Training from Other Jurisdictions

Anybody with qualifications and training from another EU Member State can apply to SOLAS for recognition of their training under the European Union (Recognition of Professional Qualifications) Regulations 2017 (S.I. 8 of 2017) and if deemed equivalent will be issued with a SOLAS CSCS card of the appropriate level (temporary services card or experienced operator's card).

7.2 Competence for Inspection

The designated person inspecting a scaffold must be competent. A competent person is a person who is fully trained, has acquired the necessary knowledge and practical experience and has received the necessary instructions for the inspection of the type of scaffold. A trained scaffolder can inspect a scaffold for which he/she is trained to erect.

While it is relatively easy to inspect for certain defects such as missing guard-rails, an untrained person may not be able to form an opinion on the stability of the scaffold.

It is permissible for people other than trained scaffolders to perform scaffold inspections but they must have the competency to carry it out. Training courses are available nationwide on scaffolding inspection.

Employers, contractors and the PSCS should seek evidence of appropriate certification of training to verify that training has been received. Periodic refresher training should be provided where appropriate.

7. Competence

7.3 Training and Instruction for Scaffold Users

All scaffold users should receive training and instruction in the use of the scaffold. It is important to provide this training and instruction because the users may not otherwise realise when they are at risk, may not request modifications in time and may interfere with the scaffold, putting themselves and others at risk.

This training may be provided as part of the site-specific induction that all people who are likely to use the scaffold, either for access or as a working platform, should receive.

Induction training should ensure that scaffold users:

- are able to recognise when a scaffold is complete, e.g. full boarding, guard-rails and toe-boards present;
- know the meaning of warning signs or scaffold tagging systems in use;
- do not interfere or make modifications to scaffolding. Modifications may only be made by a competent scaffolder with the appropriate training and certification;
- know the maximum loading capacity of the scaffold working platforms and loading towers (the training should provide specific comprehensible examples relating to the materials in use on the site);
- report defects to a designated person;
- do not throw materials from the scaffold; and
- use the designated access points and do not climb the scaffold.

7.4 Training and Instruction of Equipment Operators

The mechanical placing of materials on a scaffold may lead to significant impact loads and the overloading of the scaffold can cause a collapse of the scaffold.

Equipment operators such as crane drivers and telescopic handler operators as well as signallers (banksmen) should be competent and have received training, assessment and certification.

Lifting equipment operators should be informed of the safe working load of the scaffold working platforms and loading bays. Comprehensible examples relating to the materials in use on the site should be provided. It may be necessary to review the information provided if the materials or scaffold layout change.

Excavation close to the scaffold can undermine it. Excavator operators should be informed of the minimum distances that they should observe when excavating near the scaffold.

Appendix A: Tube and Fitting Scaffolds



Appendix A: Tube and Fitting Scaffolds

Tube and Fitting Scaffolds

While system scaffolding is the most common type of scaffolding used for many housing and commercial project, tube and fitting scaffolds are also used and are commonplace in sectors such as pharmaceutical and heavy industry projects as well as on offshore projects. Refer to I.S. EN 12811 Part 1, 2004: *Temporary works equipment – Scaffolds – Performance requirements and general design* for comprehensive information on the design and erection of tube and fitting scaffolds. Guidance on this is also available in TG20:13 Good Practice Guidance for Tube and Fitting Scaffolding.

Table A1 lists the six distributed load classes specified in I.S. EN 12811 Part 1. The requirements for concentrated and partial area loads are also included. Further details of these can be found in Table 3 of I.S. EN 12811 Part 1.

In the absence of wind, in addition to vertical imposed loads, I.S. EN 12811 Part 1 requires a notional horizontal load applied to each bay of the scaffold of not less than 2.5% of the total uniformly distributed service load on that bay or 0.3kN, whichever is greater. It should be separately applied parallel and perpendicular to the bay at the level of the working platform.

Reference should also be made to clause 6.2.9 of I.S. EN 12811 Part 1 for the design load combinations to be used. If the specifier quotes no load rating, it is recommended that the selection be made from either Table A1 in this Code of Practice or from Table 3 in I.S. EN 12811 Part 1.

The following tables are derived from I.S. EN 12811 Part 1, 2004 and I.S. EN 74 Part 1, 2005.

Tables included are extracted from relevant standards. Please reference standards for details.



Appendix A: Tube and Fitting Scaffolds

Table A1: Service Loads on Working Areas

Load Class	Uniformly distributed load on platform (kN/m ²)	Concentrated load on area 500mm x 500mm (kN)	Concentrated load on area 200mm x 200mm (kN)	Partial area load	
				(kN/m ²)	Partial area factor ⁽¹⁾
1	0.75 kN/m ²	1.50 kN	1.00 kN	-	-
2	1.50 kN/m ²	1.50 kN	1.00 kN	-	-
3	2.00 kN/m ²	1.50 kN	1.00 kN	-	-
4	3.00 kN/m ²	3.00 kN	1.00 kN	5.00 kN/m ²	0.4
5	4.50 kN/m ²	3.00 kN	1.00 kN	7.50 kN/m ²	0.4
6	6.00 kN/m ²	3.00 kN	1.00 kN	10.00 kN/m ²	0.5

(1) Each platform of load class 3,4 and 6 shall be capable of supporting a uniformly distributed partial area loading. Refer to I.S. EN 12811 Part 1 for further information.

(2) For working scaffolds pf load class 1, all platform units shall be capable of supporting class 2 service load, but this shall not apply to the scaffold structure in its entirety.

Based on I.S. EN 12811 part 1, reproduced with permission from NSAI

Appendix A: Tube and Fitting Scaffolds

Table A2: Strength Properties of Scaffold Boards (From TG5:10)

Board Thickness	Target Span	Moment of resistance of a single board where:	
		An applied load acts only on an individual board kNm	An applied load spread uniformly across a minimum of 4 boards kNm
38	1.2	0.50	0.61
38	1.5	0.65	0.81
63	2.5	1.25	1.48

Note: these figures may vary for heavy duty work and will depend on whether the boards are visually or machine graded. It will also vary if you are using different boards of different materials. Always refer to the manufacturer's information (scaffolding and boards) and the scaffolding design to determine capacity.

Table A3: Classes of Couplers (from I.S. EN74-1 2005)

Type of Coupler	Class of coupler			
	A	B	AA	BB
Right angle coupler	■	■	■	■
Swivel coupler	■	■	---	---
Parallel coupler	■	■	---	---
Sleeve coupler friction type	■	■	---	---

■ Specified class

Appendix A: Tube and Fitting Scaffolds

NOTE

Classes A and B differ in transmissible forces and moments and in values of load bearing capacity and stiffness. Couplers of classes AA and BB, used as single couplers have the same characteristics as couplers of classes A and B respectively, but they may also be used increase slipping capacity if two identical couplers AA+AA or AA + BB are positioned touching each other.

Table 2 from I.S. EN 74-1 2005, reproduced with permission from NSAI

Table A4: Characteristic Values of the Resistance for Couplers

Type of Coupler	Resistance	Characteristic Value			
		Class A	Class B	Class AA	Class BB
Right angle coupler (RA)	Slipping force $F_{s,k}$ in kN	10.0	15.0	15.0	25.0
	Cruciform bending moment $M_{B,k}$ in kNm	---	0.8	---	---
	Pull apart force $F_{p,k}$ in kN	20.0	30.0	---	---
	Rational moment $M_{T,k}$ in kNm	---	0.13	---	---
Friction type sleeve (SF)	Slipping force $F_{s,k}$ in kN	6.0	9.0	---	---
	Bending moment $M_{B,k}$ in kNm	---	2.4	---	---
Swivel coupler (SC)	Slipping force $F_{s,k}$ in kN	10.0	15.0	---	---
Parallel coupler (PC)	Slipping force $F_{s,k}$ in kN	10.0	15.0	---	---

For symbols see Figure C.3 and C.4 (refer to I.S. EN 12811-1, 2004)

Table C.1 from I.S. EN 12811-2004, reproduced with permission from NSAI

Appendix A: Tube and Fitting Scaffolds

Table A5: Widths of Access Scaffold Platforms

Width Class	Minimum Full Width (m)
W06	$0.6 \leq \text{width} < 0.9\text{m}$
W09	$0.9 \leq \text{width} < 1.2\text{m}$
W012	$1.2 \leq \text{width} < 1.5\text{m}$
W015	$1.5 \leq \text{width} < 1.8\text{m}$
W018	$1.8 \leq \text{width} < 2.1\text{m}$
W021	$2.1 \leq \text{width} < 2.4\text{m}$
W024	$2.4 \leq \text{width}$

Note: When equipment or materials are placed on the working area, consideration should be given to maintaining space for work and access.

Table1 from I.S. EN 12811 Part 1, reproduced with permission from NSAI

Appendix B: Example Checklists



Appendix B: Example Checklists

Checklist 1

is a template form for the examination of scaffolding components prior to use on site.

Checklist 2

is a template checklist for inspecting scaffolds in use (this has also been combined into a scaffold GA3 template in Appendix C).

Handover Certificate

– this is a template for the scaffold erector to be completed when handing over the scaffold to the client once erected to the client's specifications.

All these forms are templates to help contractors manage the works. They are not mandatory forms. Contractors can also use other forms to record these checks, handovers etc.



Checklist I: Inspection of Scaffolding Materials Before Use

Use this checklist to verify and record that scaffolding materials that are delivered to site are in an acceptable condition; before they are incorporated into the temporary structure.

Site:	<input type="text"/>	Reference:	<input type="text"/>
Location:	<input type="text"/>	Inspected By:	<input type="text"/>
Date:	<input type="text"/>	Copies to:	<input type="text"/>

Item	Quantity	Comments	Acceptable	
			Yes	No
Sole Boards			<input type="checkbox"/>	<input type="checkbox"/>
Base Plates			<input type="checkbox"/>	<input type="checkbox"/>
Base Jacks			<input type="checkbox"/>	<input type="checkbox"/>
Standards			<input type="checkbox"/>	<input type="checkbox"/>
Ledgers			<input type="checkbox"/>	<input type="checkbox"/>
Transoms			<input type="checkbox"/>	<input type="checkbox"/>
Intermediate Transoms			<input type="checkbox"/>	<input type="checkbox"/>
Right Angle Couplers			<input type="checkbox"/>	<input type="checkbox"/>
Swivel Couplers			<input type="checkbox"/>	<input type="checkbox"/>
Sleeve Couplers			<input type="checkbox"/>	<input type="checkbox"/>
Scaffold Tube			<input type="checkbox"/>	<input type="checkbox"/>
Decking / Scaffold Boards			<input type="checkbox"/>	<input type="checkbox"/>
Diagonal Brace			<input type="checkbox"/>	<input type="checkbox"/>
Access Stairs / Ladders			<input type="checkbox"/>	<input type="checkbox"/>
Cantilever / Stage Brackets			<input type="checkbox"/>	<input type="checkbox"/>
Bridging Ledgers			<input type="checkbox"/>	<input type="checkbox"/>
Anchorage / Ties			<input type="checkbox"/>	<input type="checkbox"/>
Brick Guards			<input type="checkbox"/>	<input type="checkbox"/>
Sheeting / Netting			<input type="checkbox"/>	<input type="checkbox"/>
Erection & Use Instructions			<input type="checkbox"/>	<input type="checkbox"/>
Scaffolding Signs & Tags			<input type="checkbox"/>	<input type="checkbox"/>
Other Component			<input type="checkbox"/>	<input type="checkbox"/>

Checklist 2: Inspection of Scaffolding in Use

Use this checklist while inspecting scaffolding that is in use. Record all defects observed and arrange for a competent scaffolder to rectify the defects (note when completed). This can help you complete form GA3.

Site:	<input type="text"/>	Reference:	<input type="text"/>
Location:	<input type="text"/>	Inspected By:	<input type="text"/>
Date:	<input type="text"/>	Copies to:	<input type="text"/>

Item	Defect and Location (use gridlines or references)	Date Corrected
Foundations		
Sole Boards		
Base Plates & Base Jacks		
Standards		
Ledgers		
Transoms		
Tie Spacing & Capacity		
Anchorage Test Results		
Facade Bracing		
Plan Bracing		
Cross Bracing		
Guard Rails		
Toe Boards		
Decking / Scaffold Boards		
Scaffolding Signs & Tags		
Loading in line with design		
Access onto Scaffolding		
User Behaviour & Housekeeping		
Unauthorised Alterations		
Anticipated Hazards next 7 days		
Other (traffic/public/electricity)		
Observations		

CODE OF PRACTICE

FOR ACCESS AND WORKING SCAFFOLDS

Certificate: Handover of Scaffolding to User

Use this certificate to record the particulars of the scaffolding that you have erected and communicate the capacity of the scaffolding to the User.

Site:	<input type="text"/>	Reference:	<input type="text"/>
Location:	<input type="text"/>	Erected By:	<input type="text"/>
Date:	<input type="text"/>	Copies to:	<input type="text"/>

Description of section of scaffolding to be handed over (use grid line and/or references to identify section)

Maximum loading capacity of Working Platforms (in kg/bay, or for non-standard bays in kg/m²)

Maximum number of Working Platforms provided (do not exceed this number)

Number and loading capacity of Loading Platforms (include details of location & use restrictions – if any)

Identify the person responsible for making periodic inspections (to be agreed with the User / Client)

Identify the person responsible for authorising modifications (to be agreed with the User / Client)

Results of pull-out tests undertaken on ring bolt anchors (where used)

Detail the design information necessary to enable other competent people to make a full inspection of the scaffold during use (i.e. type and spacing of ties; plan bracing; ledger bracing; facade bracing)

We have: (tick when done)

- Erected the scaffolding in accordance with the details above and our quotation:
- Inspected the scaffolding in accordance with our scaffolding inspection
- Inspected the scaffolding and completed GA3 Form, or similar (attached)

Signed:
Scaffolding Erector; or
Scaffolding Company

You must: (tick to confirm you understand)

- Make sure that the scaffolding is used in accordance with the details above
- Not alter the scaffolding or overload the scaffolding during use
- Make arrangements to have the scaffolding inspected at least every 7 days (see GA3 form)

Signed:
Scaffolding User; or
Contractor

Appendix C: Form GA3 Report of Results of Inspections of Work Equipment for Work at a Height



Appendix C: Form GA3 Report of Results of Inspections of Work Equipment for Work at a Height

The general GA3 for Work Equipment for Work at a height is provided as well as a scaffold specific GA3 template which incorporates the scaffold in use checklist. This may be used to record the results of inspections of work equipment for work at a height, as set out in the Safety, Health and Welfare at Work (General Application) Regulations 2007. The HSA produced these forms to facilitate the recording of information, as per Regulation 119. This is not an approved or statutory form. Reports of inspections of work equipment for work at a height may be produced in other formats.

GA3 - Report of Results of Inspections of: Work Equipment for Work at a Height

* Must specify details of any matter identified that could give rise to a risk to the safety or health of any employee -e.

Name of person (or company) for whom the inspection was carried out:

Address where inspection was carried out (site or other workplace):

Location & Description of Equipment & any Identification	Date and Time of Inspection	Results of Inspection* including defects & locations	Details of any corrective actions taken	Details of any further action necessary	Name and position of person making inspection	Signature of person who made inspection

Day to day management of the scaffolding is the responsibility of the contractor responsible for the site.

GA3 - Report of Results of Inspections of: Work Equipment for Work at a Height

This form may be used to assist in compliance with the Safety Health and Welfare at Work (General Application) Regulations 2007 Regulation 119 – Inspection of Work Equipment in relation to scaffolds, guard-rails, toe-boards, barriers or similar means of protection, fixed and mobile working platforms, nets, airbags or other collective safeguards for arresting falls, personal fall protection systems, work positioning systems, rope access and positioning techniques, fall arrest systems, work restraint systems and ladders. This is not an approved or statutory form. Reports of Inspection may be produced in other formats. This form does not substitute for reports of thorough examination of lifting equipment that may be required under other statutory provisions (see GA1 and GA2).

Safety, Health and Welfare at Work (General Application) Regulations, 2007 - Part 4 - Regulation 119

119. (1) An employer shall ensure that, as regards work equipment to which Regulations 101 to 114 apply—
- (a) where the safety of the work equipment depends on how it is installed or assembled, it is not used after installation or assembly in any position unless it has been inspected in that position,
 - (b) without prejudice to paragraphs (a) and (c), work equipment exposed to conditions causing deterioration which is liable to result in dangerous situations is inspected—
 - (i) at suitable intervals, and
 - (ii) where exceptional circumstances have occurred that are liable to jeopardise the safety of the work equipment, as soon as practicable following these exceptional circumstances, and
 - (c) without prejudice to paragraph (a), a working platform—
 - (i) used for construction work, and
 - (ii) from which an employee could fall 2 m or more, is not used in any position unless it has been inspected in that position within the previous 7 days or, in the case of a mobile working platform, inspected on the site, within the previous 7 days.
- (2) A person carrying out an inspection of work equipment to which paragraph (1)(c) applies shall—
- (a) promptly prepare a report containing the particulars as set out in Schedule 5, and
 - (b) within 24 hours of completing the inspection, provide the report, or a copy thereof, to the person on whose behalf the inspection was carried out.
- (3) An employer receiving a report under paragraph (2) shall keep the report or a copy of the report—
- (a) at the site where the inspection was carried out until the construction work is completed, and
 - (b) thereafter, at an office of the employer.
- (4) An employer shall ensure that—
- (a) no work equipment under the employer's control is used in another place of work unless it is accompanied by evidence that the last inspection required to be carried out under this Regulation has been carried out, and
 - (b) the result of an inspection under this Regulation is recorded and kept available for inspection by an inspector for 5 years from the date of inspection.

Day to day management of the scaffolding is the responsibility of the contractor responsible for the site.

Scaffold GA3 Report of Results of Inspections of Scaffolds

Scaffold Owner:	<input type="text"/>	Signature:	<input type="text"/>
Scaffold Inspector:	<input type="text"/>	Signature:	<input type="text"/>
Site Address:	<input type="text"/>	Location / Description of Scaffold:	<input type="text"/>
Date & Time of inspection:	<input type="text"/>		

Item Inspected	Condition (include any defects found)	Corrections taken / required
Foundations		
Sole Boards		
Base plates & Base Jacks		
Standards		
Ledgers		
Transoms		
Tie Spacing & Capacity		
Anchorage test results		
Façade bracing		
Plan bracing		
Cross bracing		
Guard rails		
Toe Boards		
Decking / scaffold boards		
Scaffolding signs and tags		
Loading in line with design / Manufacturer's instructions		
Access / egress		
User behaviour / housekeeping		
Unauthorised alterations		
Anticipated hazards (next 7 days)		
Other (traffic, public, electricity)		

Other outcomes of inspection / observations:

Appendix C: Form GA3 Report of Results of Inspections of Work Equipment for Work at a Height

NOTES

This form may be used to assist in compliance with the Safety Health and Welfare at Work (General Application) Regulations 2007 Regulation 119 – Inspection of Work Equipment in relation to scaffolds, guard-rails, toe-boards, barriers or similar means of protection, fixed and mobile working platforms, nets, airbags or other collective safeguards for arresting falls, personal fall protection systems, work positioning systems, rope access and positioning techniques, fall arrest systems, work restraint systems and ladders. This is not an approved or statutory form. Reports of Inspection may be produced in other formats. This form does not substitute for reports of thorough examination of lifting equipment that may be required under other statutory provisions (see GA1 and GA2).

Safety, Health and Welfare at Work (General Application) Regulations, 2007 - Part 4 - Regulation 119

119.

- (1) An employer shall ensure that, as regards work equipment to which Regulations 101 to 114 apply—
 - (a) where the safety of the work equipment depends on how it is installed or assembled, it is not used after installation or assembly in any position unless it has been inspected in that position,
 - (b) without prejudice to paragraphs (a) and (c), work equipment exposed to conditions causing deterioration which is liable to result in dangerous situations is inspected—
 - (i) at suitable intervals, and
 - (ii) where exceptional circumstances have occurred that are liable to jeopardise the safety of the work equipment, as soon as practicable following these exceptional circumstances, and
 - (c) without prejudice to paragraph (a), a working platform—
 - (i) used for construction work, and
 - (ii) from which an employee could fall 2 m or more, is not used in any position unless it has been inspected in that position within the previous 7 days or, in the case of a mobile working platform, inspected on the site, within the previous 7 days.
- (2) A person carrying out an inspection of work equipment to which paragraph (1)(c) applies shall—
 - (a) promptly prepare a report containing the particulars as set out in Schedule 5, and
 - (b) within 24 hours of completing the inspection, provide the report, or a copy thereof, to the person on whose behalf the inspection was carried out.
- (3) An employer receiving a report under paragraph (2) shall keep the report or a copy of the report—
 - (a) at the site where the inspection was carried out until the construction work is completed, and
 - (b) thereafter, at an office of the employer.
- (4) An employer shall ensure that—
 - (a) no work equipment under the employer's control is used in another place of work unless it is accompanied by evidence that the last inspection required to be carried out under this Regulation has been carried out, and
 - (b) the result of an inspection under this Regulation is recorded and kept available for inspection by an inspector for 5 years from the date of inspection.

Day to day management of the scaffolding is the responsibility of the contractor responsible for the site.

Appendix D: Weights of Typical Building Materials



Appendix D: Weights of Typical Building Materials

Mass of Scaffolding Materials

The following tables have been derived from BS 5973, 1993 and its replacement I.S. EN 12811, 2004 (reproduced with permission from NSAI) and from guidance documents referenced in Appendix E.

Table D1: Mass of Scaffolding Materials

Scaffolding Materials	Mass
Steel Scaffold Tube 48.3mm diameter	4.37kg/m
Steel couplers and fittings	1.00kg to 2.25kg
Boards (225mm wide) 38mm thick } 50mm thick } 225mm wide 63mm thick }	6kg/m or 25kg/m ² 8kg/m or 33kg/m ² 10kg/m or 41kg/m ²

Based on BS 5973, 1993

Appendix D: Weights of Typical Building Materials

Table D2: Mass of Quantities of Scaffolding Materials

Mass (tonne)	Length of steel tube (m)	Approximate number of steel fittings (average 1.8kg)	Number of boards (63mm x 225mm of length 3.9m)
1	228	560	46
2	457	1,120	92
3	685	1,680	138
4	915	2,240	184
5	1,143	2,800	230
7	1,600	3,920	322
10	2,286	5,600	460
15	3,430	8,400	690
20	4,570	11,200	920
25	5,720	14,000	1,150

Table D3: Mass of People and Materials

Item	Mass
Person (average)	80kg
Person with small tools (average)	90kg
Spot board and mortar	30kg
Wheelbarrow full of mortar	150kg
Tarpaulins and fixings	1kg/m ²
Ladders and fixings	8kg/m
500 bricks	1,375kg
500 concrete bricks (15N/mm ²)	1,750kg
50 concrete blocks (100 x 215 x 440mm, 5N/mm ²)	1,020kg
Timber (softwood)	500kg/m ³ to 650kg/m ³
180 litres of water or liquids in containers	200kg
Packaged flooring tiles, ceramic tiles, roofing tiles, slates	1,600kg/m ³

Appendix D: Weights of Typical Building Materials

Table D4: Mass of Unboarded 2m Lift One Bay Long

(including two standards, two ledgers, two transoms and a portion of bracing, ties and fittings. Guard-rails are not included)

Width of Scaffold	Length of Bay (m)						
	1.2	1.5	1.8	2	2.1	2.4	2.7
	Weight (s) of unboarded 2m lift						
m	kN	kN	kN	kN	kN	kN	kN3
3 boards	0.55	0.57	0.6	0.62	0.63	0.65	0.68
4 boards	0.56	0.58	0.61	0.63	0.63	0.66	0.69
5 boards	0.57	0.59	0.62	0.64	0.64	0.67	0.70
6 boards	0.58	0.6	0.63	0.65	0.65	0.68	0.71

Appendix D: Weights of Typical Building Materials

Table D5: Additional Weight of a Boarded Lift (with imposed service load) One Bay Long

(this includes the additional weight of one boarded lift: the boards, the toe-board, the principle and intermediate guard-rails, fittings and the service-imposed load on the lift. The figures do not include weight of the scaffold itself, which is given in Table D4)

Width of Scaffold	Service imposed load	Length of Bay (m)						
		1.2	1.5	1.8	2	2.1	2.4	2.7
		Extra Weight (w) of boarded lift						
m	kN/m ²	kN	kN	kN	kN	kN	kN	kN
3 boards	0	0.48	0.58	0.67	0.73	0.76	0.93	1.02
3 boards	0.75	1.09	1.33	1.58	1.74	1.82	2.14	2.39
4 boards	0	0.56	0.67	0.78	0.85	0.89	1.08	1.19
4 boards	0.75	1.37	1.68	1.99	2.2	2.3	2.7	3.014
4 boards	1.5	2.18	2.69	3.21	3.55	3.72	4.32	4.83
4 boards	2	2.72	3.37	4.02	4.45	4.67	5.4	6.05
5 boards	0	0.63	0.76	0.89	0.97	1.01	1.23	1.36
5 boards	0.75	1.65	2.03	2.4	2.66	2.78	3.26	3.64
5 boards	1.5	2.66	3.29	3.92	4.35	4.56	5.28	5.91
5 boards	2	3.33	4.13	4.94	5.47	5.74	6.63	7.43
5 boards	2.5	4.01	4.98	5.95	6.6	6.92	7.98	8.95
5 boards	3	4.68	5.82	6.96	7.72	8.1	9.33	10.47
6 boards	0	0.71	0.85	1	1.09	1.14	1.38	1.53
6 boards	2	3.95	4.9	5.85	6.49	6.81	7.86	8.82
6 boards	2.5	4.76	5.91	7.07	7.84	8.23	9.48	10.64
6 boards	3	5.57	6.93	8.28	9.19	9.63	11.1	12.46

Note:

All boards are 225mm wide x 38mm thick

The values for 4 and 5 board lifts are the same when one board is fitted on the inside face, i.e. 3+1 and 4+1

Appendix E: Additional Information Summary of Changes from Previous COP

Additional References / Information Sources



Appendix E: Additional Information Summary of Changes from Previous COP

The key changes to the COP from the previous 2008 version are:

- the requirement that all scaffolding requires a design (allowing for proprietary system scaffolding manufacturer's designs to be used for standard configurations and other standard designs, such as TG20, to be used as appropriate);
- the increased emphasis on the requirement to identify if a bespoke design scaffold is necessary at the earliest possible stage of a project and for the Project Supervisor Design Process to co-ordinate this temporary works design with the permanent works designer;
- the introduction of the Temporary Works Co-ordinator to assist the project supervisors in their duties including helping effective communication and co-ordination between the PSDP, designers, the PSCS and the contractors involved in the temporary works/scaffolders;
- further requirements for prioritising collective protection measures for scaffolders while erecting, modifying and dismantling scaffolding. The use of leading guard rails and scaffold step systems is introduced and the removal of the previous allowance for scaffolders to work off partially boarded decks;
- the removal of allowance for a non-scaffolder to remove handrails under certain circumstances such as when loading materials, and the emphasis on providing appropriate gate systems at loading bays that maintain edge protection to workers during loading operations;
- the requirement that stairway access should be provided where it is reasonably practicable to do so, particularly where there is a high usage rate and/or where materials or tools need to be carried frequently by hand;
- the requirement for using flame retardant sheeting material for sheeting scaffold that will have hot works carried out in or near it, or that is erected near the public;
- requirements to ensure all decking boards are adequately secured and emphasis on the risks of displacement of boards due to high winds;
- reduction of maximum gap between scaffold deck and the structure from 300mm to 225mm;
- requirements for the inspection of decking boards for defects and for the correct storing of timber boards when not in use;
- clarifications around training of persons inspecting scaffolding;
- technical updates with regards to references to current legislation and standards;
- provision of new template GA3 form for scaffolds incorporating 'in-use' checklist;
- removal and/or replacement of some illustrations.

Appendix E: Additional Information Additional References /Information Sources

Statutory Provisions

www.hsa.ie

- Safety, Health and Welfare at Work Act 2005
- Safety, Health and Welfare at Work (Construction) Regulations 2013
- Safety, Health and Welfare at Work (General Application) Regulations 2007-2016

Irish Standards

www.nsai.ie | www.standards.ie

• I.S. EN 39, 2001	Loose steel tubes for tube and coupler scaffolds – technical delivery conditions
• I.S. EN 74-1, 2005	Couplers, spigot pins and baseplates for use in falsework and scaffolds – Part 1: Couplers for tubes – Requirements and test procedures
• I.S. EN 354, 2002	Personal protective equipment against falls from a height – Lanyards
• I.S. EN 355, 2002	Personal protective equipment against falls from a height – Energy absorbers
• I.S. EN 358, 2000	Personal protective equipment for work positioning and prevention of falls from a height – Belts for work positioning and restraint and work positioning lanyards
• I.S. EN 361, 2002	Personal protective equipment against falls from a height – Full body harnesses
• I.S. EN 362, 2005	Personal protective equipment against falls from a height – Connectors
• I.S. EN 363, 2002	Personal protective equipment against falls from a height – Fall arrest systems
• I.S. EN 364, 1993	Personal protective equipment against falls from a height – Test methods
• I.S. EN 365, 2006	Personal protective equipment against falls from a height – General requirements for instructions for use, maintenance, periodic examination, repair, marking and packaging

Appendix E: Additional Information Additional References /Information Sources

• I.S. 745, 1986	Machine-graded home-grown timber scaffold boards
• I.S. EN 1004, 2005	Mobile access and working towers made of prefabricated elements – Materials, dimensions, design loads, safety and performance requirements
• I.S. EN 1065, 1999	Adjustable telescopic steel props – Product specifications, design and assessment by calculation and tests
• I.S. EN 1995-1-1, 2005	Design of timber structures
• I.S. EN 1263 Part 1, 2002	Safety nets – Part 1: Safety requirements, test methods
• I.S. EN 1263 Part 2, 2002	Safety nets – Part 2: Safety requirements for the positioning limits
• I.S. EN 1298, 1996	Mobile access and working towers – Rules and guidelines for the preparation of an instruction manual
• I.S. EN 10210 Parts 1 & 2, 2006	Hot finished structural hollow sections of non-alloy and fine grain steels
• I.S. EN 12385 Parts 1 & 2, 2002	Steel wire ropes – Safety – General requirements
• I.S. EN 12810 Part 1, 2004	Façade scaffolds made of prefabricated components – Part 1: Products specifications
• I.S. EN 12810 Part 2, 2004	Façade scaffolds made of prefabricated components – Part 2: Particular methods of structural design
• I.S. EN 12811 Part 1, 2004	Temporary works equipment – Scaffolds – Performance requirements and general design
• I.S. EN 12811 Part 2, 2004	Temporary works equipment – Part 2: Information on materials
• I.S. EN 12811 Part 3, 2002	Temporary works equipment – Part 3: Load testing
• I.S. EN 12812, 2004	Falsework – Performance requirements and general design

Appendix E: Additional Information Additional References /Information Sources

British Standards

www.bsigroup.com/en-GB/

• BS 648, 1964	Schedule of weights of building materials
• BS 1129, 1990	Specification for portable timber ladders, steps, trestles and lightweight stagings
• BS 1139 Parts 1 to 5	Metal scaffolding
• BS 2482, 2009	Specification for timber scaffold boards
• BS 2830, 1994	Specification for suspended access equipment (suspended chairs, traditional steeplejack's seats, work cages, cradles and platforms) for use in the building, engineering, construction, steeplejack and cleaning industries
• BS 4978, 2007	Visual strength grading of softwood. Specification
• BS 5973, 1993	Code of practice for access and working scaffolds and special scaffold structures in steel (withdrawn)
• BS 5975, 2008	Code of practice for falsework
• BS 6180, 2011	Barriers in and about buildings. Code of practice
• BS EN 1991-1-1: 2002	Actions on structures
• BS 6399 Part 2, 1997	Loading for buildings. Code of practice for wind loads
• BS 6399 Part 3, 1988	Loading for buildings. Code of practice for imposed roof loads

Appendix E: Additional Information Additional References /Information Sources

Health and Safety Authority Guidance

www.hsa.ie

- Guidance to the Safety, Health and Welfare at Work Act 2005
- Guidance to the Safety, Health and Welfare at Work (Construction) Regulations 2013
- Guidance to the Safety, Health and Welfare at Work (General Application) Regulations 2007
- Code of Practice for Avoiding Danger from Overhead Electricity Lines
- Code of Practice for Safety in Roofwork
- Safe Use of Work Platforms/Trestles – Information Sheet

Electricity Supply Board

www.esb.ie/esbnetworks

- Code of Practice for Avoiding Danger from Overhead Electricity Lines

An tSeirbhis Oideachais Leanunaigh agus Scileanna (SOLAS) www.solas.ie

Health and Safety Executive (UK) Guidance

www.hse.gov.uk

- HSG33 Safety in Roofwork
- INDG402 Guide on the Safe Use of Ladders and Stepladders
- CIS10 Tower Scaffolds
- CIS56 Safe Erection, Use and Dismantling of Falsework

Appendix E: Additional Information Additional References /Information Sources

National Access and Scaffolding Confederation (UK)

www.nasc.org.uk

- NASC Health & Safety and Technical guidance titles, other than pocket guides and the TG20 suite of publications, are available to download free of charge from the NASC website
- SG4:15 Preventing Falls in the Scaffolding Industry
- TG20:13 Guide to Good Practice for Tube and Fittings Scaffolding
- TG4:11 Anchorage Systems for Scaffolding

Prefabricated Access Suppliers' and Manufacturers' Association (UK)

www.pasma.co.uk

- PASMA Operator's Code of Practice
- DVD – Guide to the Safe Use of Mobile Access Towers
- DVD – Don't Fall for It!

Building Research Establishment (UK)

www.bre.co.uk

- BRE Digest 284 Wind Loads on Canopy Roofs
- BRE Digest 346 Parts 1 to 8, Assessment of Wind Loads
- BRE Digest 436 Parts 1 to 3, Wind Loads on Buildings

Other

- H. B. Walker (1975), *Wind Forces on Unclad Tubular Structures*, Croydon: Constructional Steel Research and Development Organisation, Constrado publication 1/75

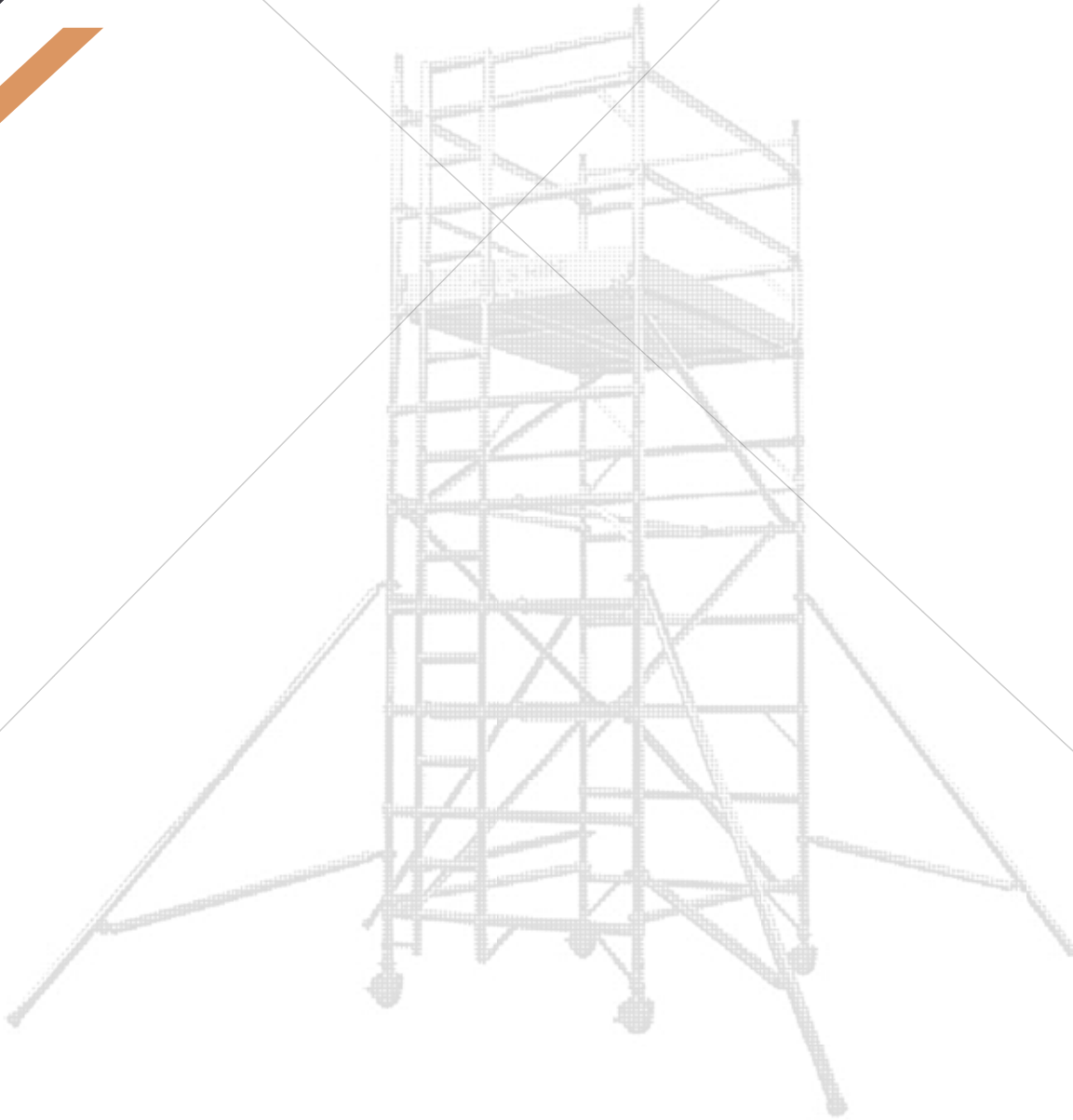

Further Information and Guidance:

Visit our website at www.hsa.ie, telephone our contact centre on **1890 289 389** or email wcu@hsa.ie

Use BeSMART, our free online risk assessment tool at www.besmart.ie

Check out our range of free online courses at www.hslearning.ie

